

The BAY MANSION is a Dollhouse of many faces - and a kit of many pieces. To help you identify parts and enhance your pleasure in doing this kit, we have:

- a. Illustrated, named, and dimensioned individual parts in the progressive steps in the instructions.
- b. Subpacked "sets" of parts that make up particular sub-assemblies, i.e. porches, tower top, etc. Subpacks are contained by wrapping paper, rubber bands, or plastic bags.
- c. Included identifying labels with most subpacks - with parts lists where necessary.

To retain the benefit of the organization inherent in our packing, it would be best not to unpack subpacks until you have reached the appropriate step in the assembly.

The list of subpacks and their pertinent steps in the instructions are:

<u>Subpacks</u>	<u>Instruction Step #</u>
1. House Underframe .....	2
2. Dormer Windows & Frames & 4 windows.....	5
3. Overmolding and Tower Spacer for Roof Top.....	12
4. L-strips, stancion and outside corner.....	8, 9, 15, 19, 32
5. Front Steps.....	13
6. Tower Top.....	21
7. Side Porch.....	24
8. Front Porch.....	25
9. First Floor Landing.....	30
10. Fascia and Bead Trim.....	32
11. Eave Brackets.....	32
12. Top Bay Molding.....	32
13. Roof Top Rails.....	35
14. Roof Top Rail Dowels & Post Balls.....	35
15. Partitions.....	34
16. Exterior Wooden Window Trim.....	33
17. Stairs.....	38
18. 3/8" Facing Strips.....	39
19. 1/2" Facing Strips.....	39

## THE BAY MANSION DOLLHOUSE KIT

by

WALMER DOLLHOUSES  
2100 Jefferson Davis Hwy.  
Alexandria, Va. 22301  
(703) 548-8804

Don't even THINK of proceeding with assembly of this kit without constant reference to these instructions. They've been prepared to be as clear and unburdensome as we could make them. To save grief, please use them.



1. SQUARE is the key word in the assembly of the BAY MANSION.
2. WHERE is equally important. Be sure to use a level and flat surface for assembly. If you build it square on a level and flat surface, it will really be square. If you build it on an uneven surface, it will shift out of square whenever it is moved to another surface. This is especially true of such a tall structure.
3. TOOLS AND SUPPLIES NEEDED - Sandpaper, tape measure, white glue, hammer, fine tooth saw, square, masking (or scotch) tape, small clamps, drill, 3/32" and 3/8" bits, small screw driver, nail punch.

Three Helpful Notes:

1. When nailing two small parts together, insert the nail almost through the first part before joining it with the second part. Then make the joint and nail through. This helpful note will be referred to as HN #1 where applicable.
2. Paint small parts before assembly with larger parts of different color, e.g. brackets, molding, window trim, etc.
3. Wallpapering of the outside walls before assembly of the dollhouse is much easier than after. A diagram of the back showing the lines separating the rooms and floors is provided.

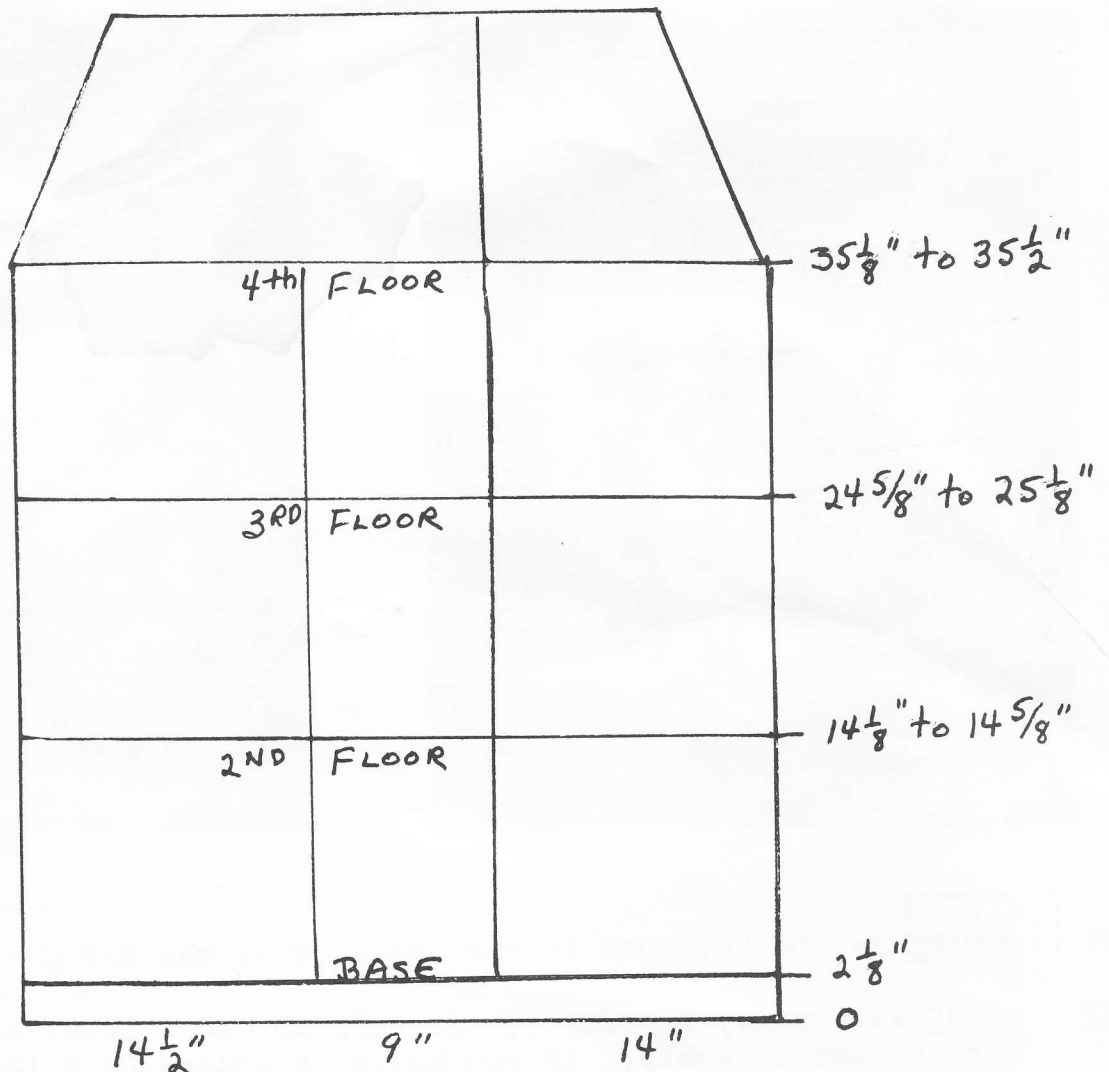

SEQUENTIAL ASSEMBLY INSTRUCTIONS

1. SANDPAPERING

Extensive sandpapering is not required since almost all edges of the plywood are covered with molding, corners, or facings. Sandpaper only to the extent necessary to remove frayed wood that would inhibit good fits of the parts during assembly.

2. SUB-ASSEMBLY OF UNDERFRAME, BASE AND BASE EXTENSION

Base is 1/4" plywood, 37 1/16" x 19".

Base Extension is 1/4" Plywood, 6 1/2" x 9 1/32"

<u>Underframe Pine:</u>	1 pc. 37 1/16"
	2 pcs. 24"
	2 pcs. 17 1/2"
	2 pcs. 7 1/2"
	1 pc. 9"
	1 pc. 14 7/32"
	1 pc. 13 27/32"

The base is not symmetrical. Be sure to observe carefully the placement of the 14 7/32" and 13 27/32" pieces of underframe.

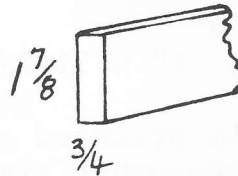

- a. Using the 17 1/2" pieces for proper spacing (and 1 1/2" nails), glue and nail the 14 7/32" and 13 27/32" pieces onto the 24" pieces as shown (HN #1).

(SEE HELPFUL NOTE #1)

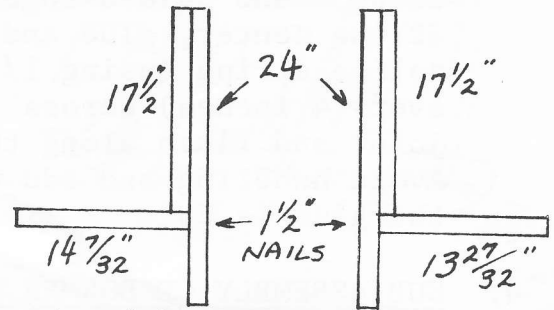

- b. Glue and nail the joints at  $b_1$  and  $b_2$  (HN #1).
- c. Using a square for alignment, glue and nail the assembled pieces from part a. above at  $c_1$  and  $c_2$ . Be sure the 14 7/32" underframe is on the left side.
- d. Using a square and one of the 7 1/2" pieces as a temporary spacer, glue and nail at  $d_1$  and  $d_2$ .
- e. Glue and nail the 9" piece at  $e_1$  and  $e_2$ .
- f. Glue and nail the two 7 1/2" pieces/and then glue and nail them together at  $f_1$  and  $f_2$  as shown.
- g. Now - reconfirm that the 14 7/32" section of the underframe is to the left and then glue the Base (1/4" plywood 37 1/16" x 19"), good side up, to the Underframe flush all around.
- h. Glue the Base Extension (1/4" plywood, 6 1/2" x 9 1/32") to the underframe. Apply weight until the glue sets.

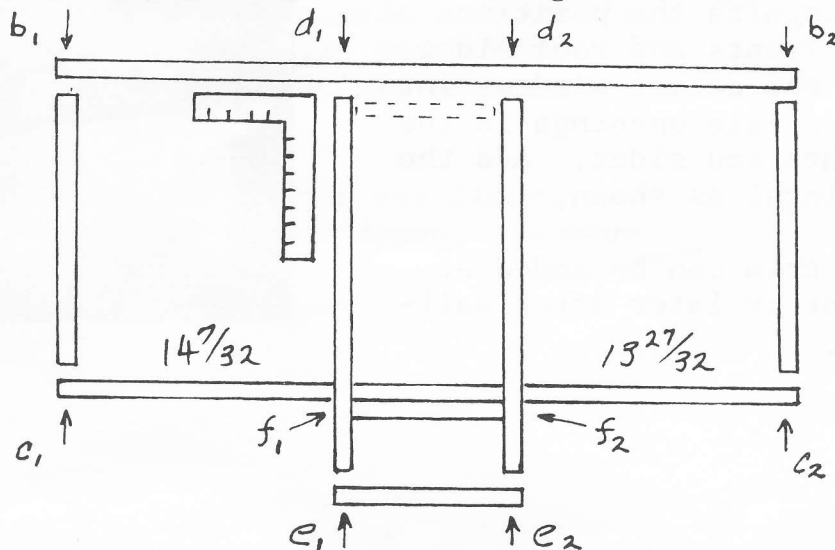

### 3. SPLICE THE BACK PANELS

The back panels are not identical.

Center Splice Strip  $44\frac{1}{2}"$   
3/8" Plywood, 2" x ~~43~~  $43\frac{1}{2}"$

Top Splice Strip  
3/8" Plywood, 1" x  $31\frac{3}{4}"$

With the back panels oriented as shown - and pushed together tightly at the center, glue and nail the splice strips (using 1/2" nails every 4 inches) across the center joint and flush along the top edge. Avoid handling and add weight until the glue is set.

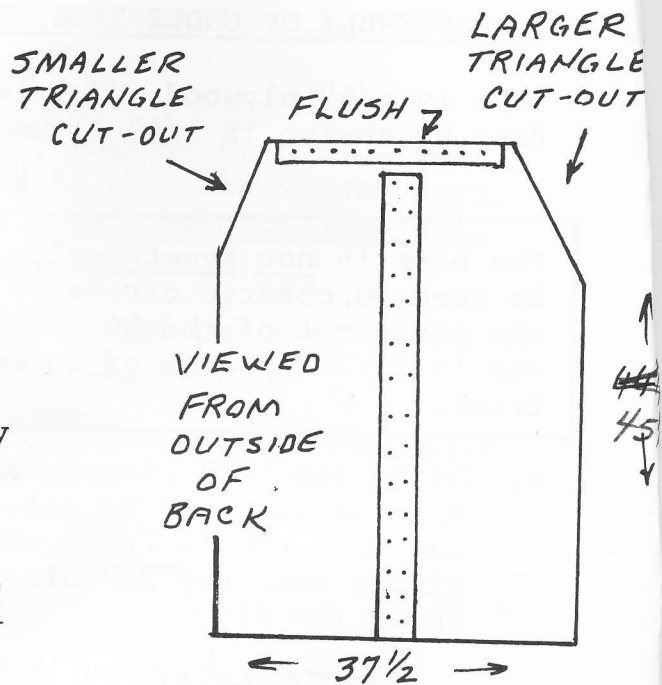

### 4. SUB-ASSEMBLY OF DORMER WINDOWS

These dormer windows are unique in that the lower part of the window is recessed inside the slanting roof surface. (See front photograph). Orient the two side frames and the sill as shown. Using the window frame as the center structure, glue the side frames and the sill to each other and to the window frame. Apply rubber bands or tape to hold pressure until the glue is set.

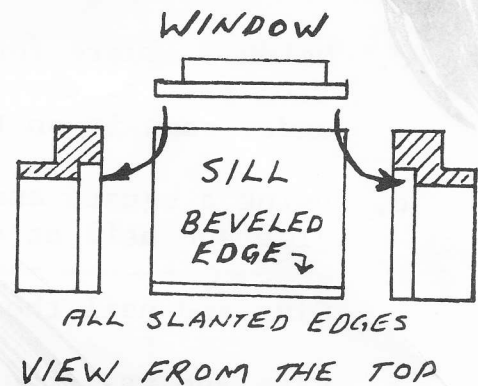

### 5. INSTALLATION OF DORMER WINDOW INTO ROOF FRONTS AND ROOF SIDES

When glue is set on dormer windows sub-assembly, refer to the photograph on the front cover to properly recognize the positions of the roof fronts and roof sides and glue the dormer windows into the appropriate openings in the roof fronts and sides. Add the dormer lintel as shown.

Interior trim can be added at this point or later after wall-papering.

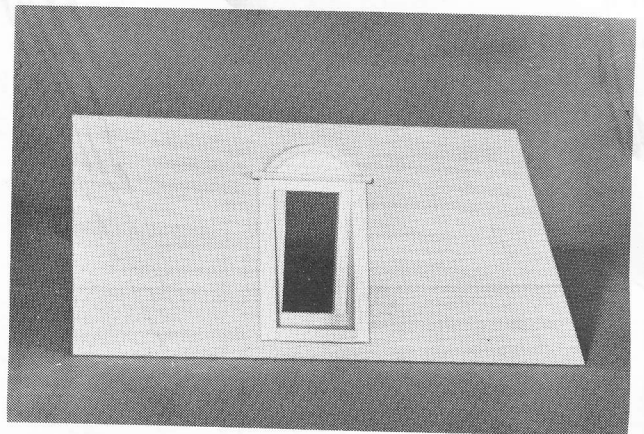

6. SUB-ASSEMBLY OF:

Front Bay Panels (3 ea.)  
3/8" Plywood, 23 1/2" long

Bay Floors (3 ea.)  
1/2" Plywood

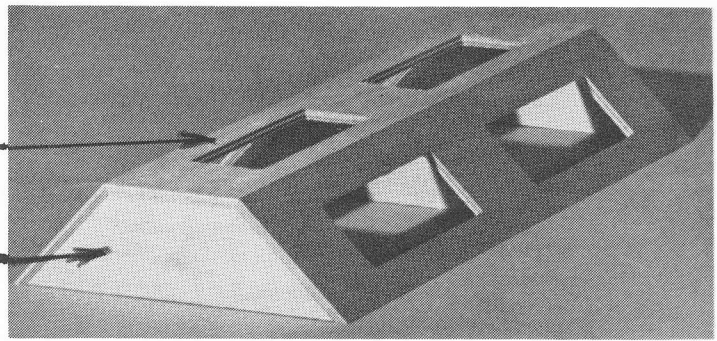

- a. Lay the three Front Bay Panels flat with mitered surfaces up and <sup>NARROW</sup> wide spaces all at the same end. Draw lines 12 1/2" and 13" up from the wide end as shown.

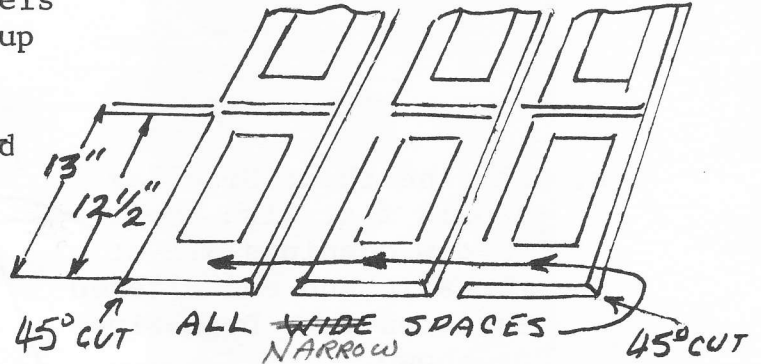

- b. The center bay panel is mitered at 22 1/2° on both sides.

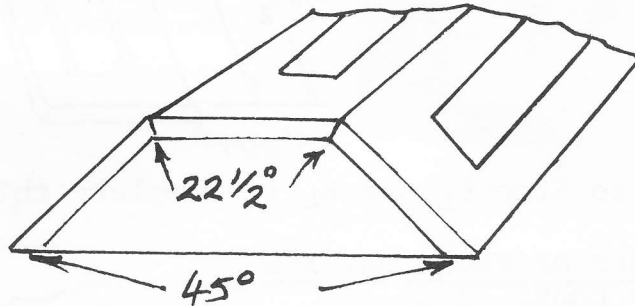

The left and right panels are mitered at 22 1/2° at the center joints, 45° at the outer edge joints.

- c. -Start by gluing and nailing the center bay panel flush to the center section of the top and bottom Bay Floors. Be careful to obtain accurate spacing.

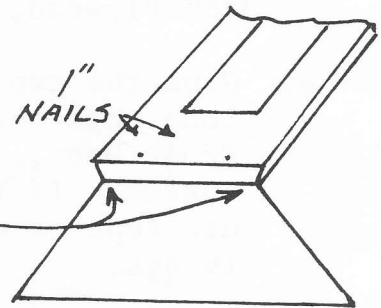

-Glue and nail the side panels in place - again be sure all wide spaces under the openings are at the same end. When nailing, squeeze the joints between the panels tight.

-Glue and nail the center bay floors in place between the lines drawn. Squeeze the joints.

7. SUB-ASSEMBLY OF:

Side Bay Panels (3 ea.)  
3/8" Plywood 31 3/8" long



Bay Floors (3 ea.)  
1/2" Plywood

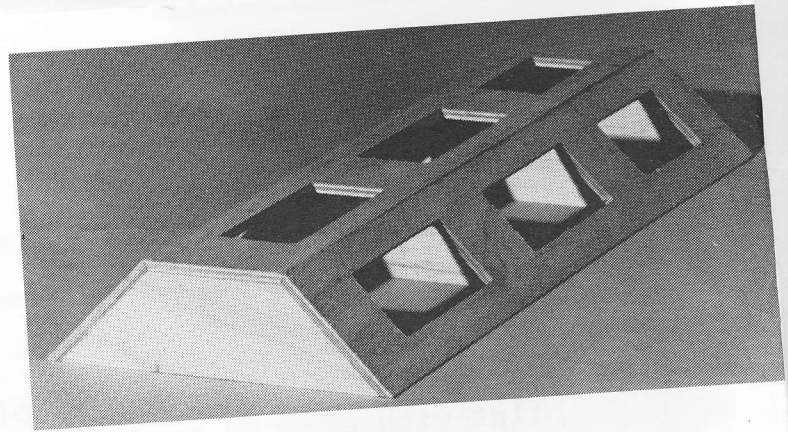

- a. Lay the three Side Bay Panels flat with small window openings all at the same end and mitered surfaces up. Draw lines as shown.

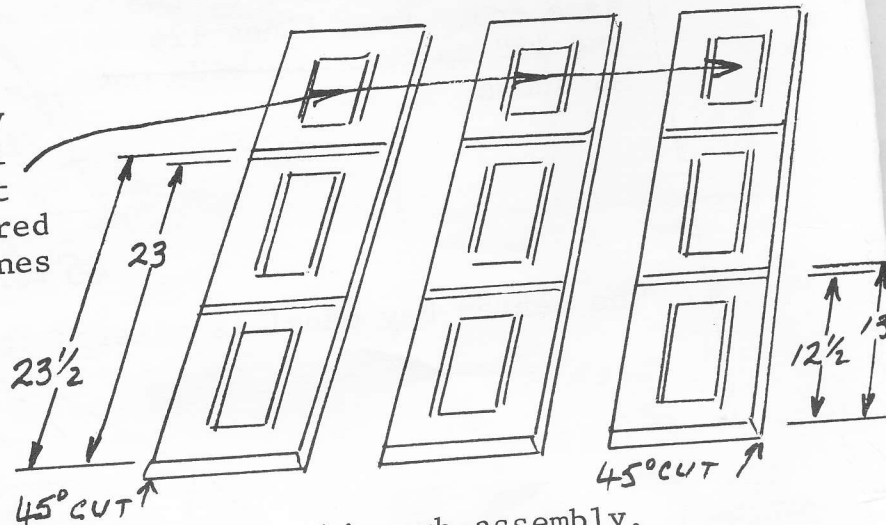

- b. Refer to Step 6<sub>b</sub> and 6<sub>c</sub> to complete this sub-assembly.

8. SUB-ASSEMBLY OF FRONT BAY AND LEFT FRONT DOOR

Left Front Door  
3/8" Plywood, 13 1/2" x 34 7/8"

- a. Glue the two stancions (34 7/8" long onto the edges of the Left Front Door, flush at top and bottom. If fit is not tight, use tape or clamps until glue is set.

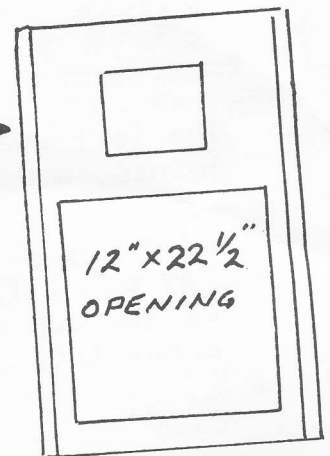
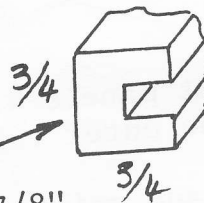

- b. Using 1" nails, glue and nail the front bay to the left front door as shown. Center the bay assembly in door opening during nailing. Drive side nails at an angle to align with the side bay panels. Use nail punch as nails come close to stancions.

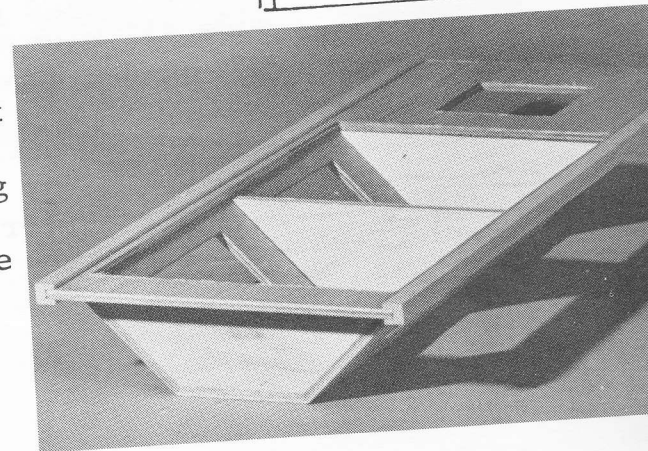

9. SUB-ASSEMBLY OF:

Side Bay



Right Side Door

3/8" Plywood, 15 15/16" x 34 7/8"  
with a 12" x 30 3/8" opening

2 1/2" At Top, 2" At Bottom  
of Door

Refer to Step 8<sup>a</sup> and 8<sup>b</sup>  
to complete this sub-<sup>a</sup> sub-<sup>b</sup>  
assembly

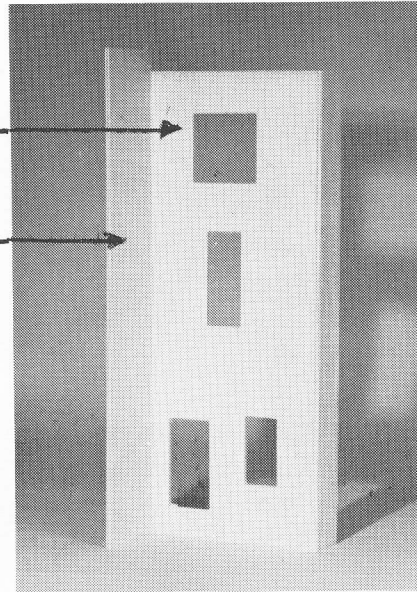

10. SUB-ASSEMBLY OF:

Right Front

3/8" Plywood, 13 27/32" x 35 1/16"



Right Tower Side

3/8" Plywood, 6 1/8" x 36 11/16"



Right Side Strip

3/8" Plywood, 3 3/8" x 35 1/16"

Be sure door opening is oriented  
as shown.

Using HN #1, and 1" nails, glue  
joints and nail as shown. Set  
aside to dry.

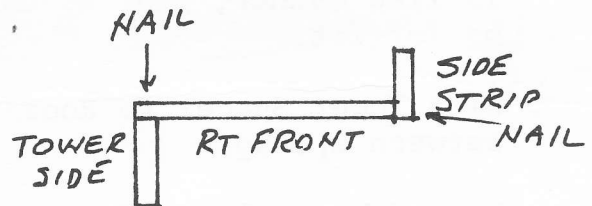

11. SUB-ASSEMBLY OF:

Front Strip

3/8" Plywood 1 1/2" x 35 1/16"



Left Tower Side

3/8" Plywood 6 1/8" x 36 11/16"

With Front Strip overlapping  
Tower Side, glue the joint and  
nail as shown.

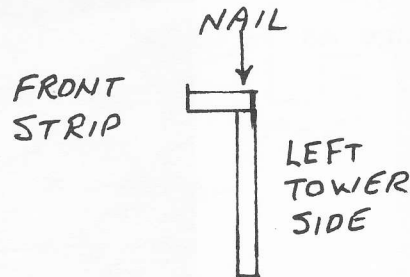



12. SUB-ASSEMBLY OF OVERMOLDING AND TOWER SPACER ONTO ROOF TOP

Overmolding

Cross section a.  
2 pieces →

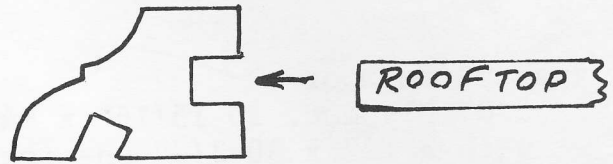

Cross section b.  
2 pieces →

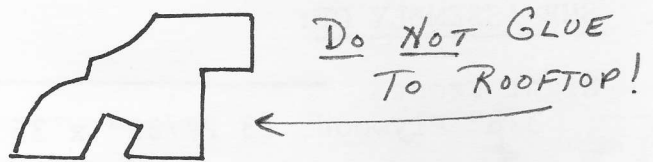

Tower Spacer 9 3/4"

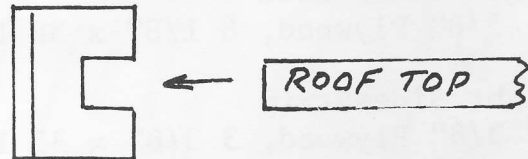

Apply glue to the groove in a<sub>1</sub> and glue it as shown - using b<sub>1</sub> to get a good corner fit.

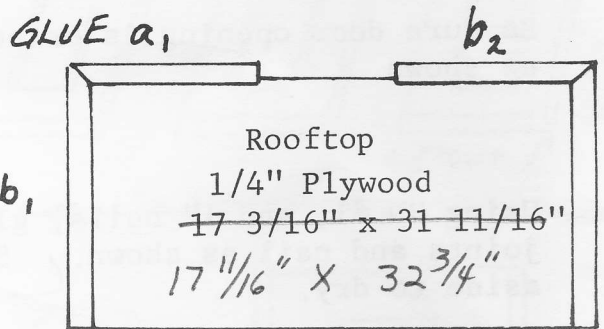

In like manner, glue a<sub>2</sub> using b<sub>2</sub> for fit.

Glue Tower Spacer to Roof Top between a<sub>1</sub> & b<sub>2</sub>.

b<sub>1</sub> and b<sub>2</sub> apply to Step 31.

13. SUB-ASSEMBLY OF FRONT STEPS

Parts of front steps are in separate subpack.

Take the 4 steps, 6" long, and glue them together as shown. Glue the two side walls to the edge of the step as shown (flush in the back). Glue the 7 3/4" step at the lower front edge as shown.

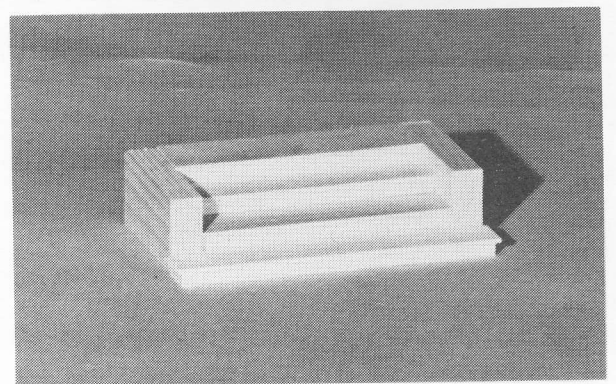
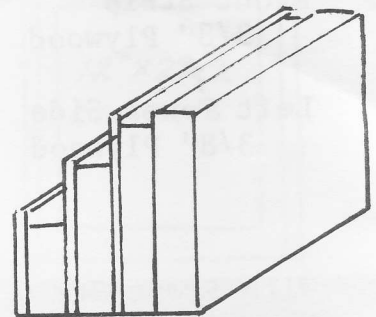

NOTE: Photos for steps 14 and 15 show the correct positions of parts in the sub-assemblies. For convenient gluing and nailing, it may be desirable to stand the base on edge and use clamps to hold parts securely together while nailing.

14. INSTALLATION OF LEFT SIDE AND BACK ONTO BASE

With openings oriented as shown, (HN #1), glue and nail (1" nails) the lower edge of the left side to the underframe of the base. Left side is to be flush with both front and rear edges of the base.

Note: It is very important that the base and vertical walls be flush at the bottom edges. Any gaps underneath will alter the vertical dimensions and cause complications as the assembly proceeds upwards.

With back oriented as shown, glue and nail (1" nails) the back onto the underframe of the base and left side. Back is flush at the right rear corner and overlaps the left side. Nailing is through the edge of the back and into the edge of the left side.

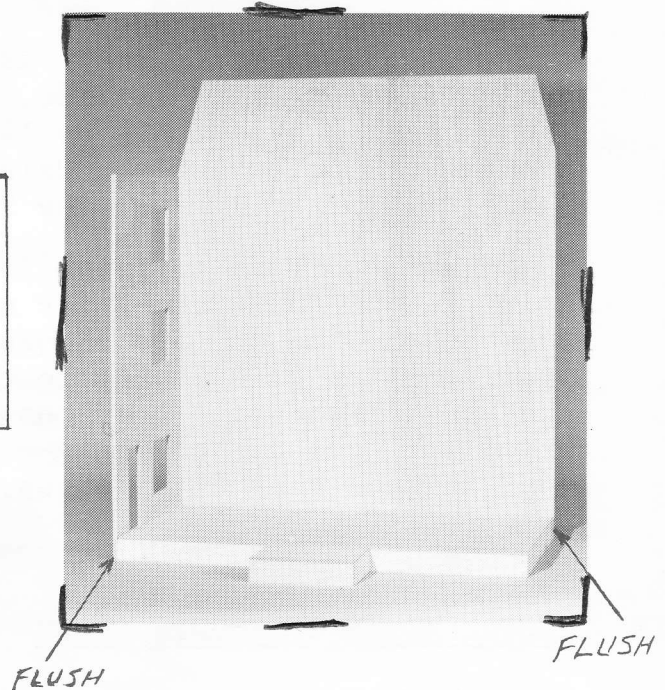

15. INSTALLATION OF RIGHT FRONT, RIGHT TOWER SIDE, AND RIGHT SIDE STRIP SUB-ASSEMBLY ONTO BASE

This sub-assembly should fit precisely around the base as shown. Using 1" nails, glue and nail the sub-assembly to the underframe of the base.

INSTALLATION OF L-STRIP ONTO LEFT FRONT AND RIGHT REAR EDGES

Both L-strips are 35 1/16" long with a cross section as shown. Glue the L-strips onto the outside of the left front and the right rear corners of the house as shown. Use masking tape to hold the L-strips secure until glue is set. Clamps even better.

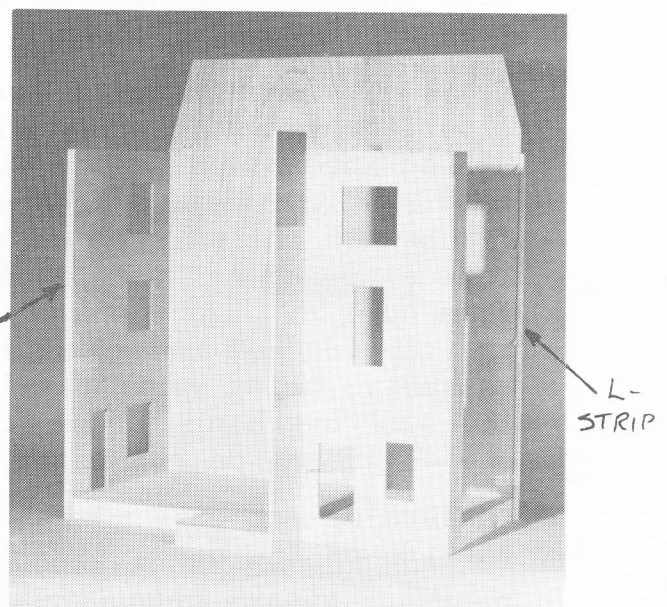
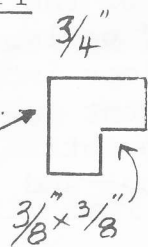

## 16. INSTALLATION OF SECOND AND THIRD FLOORS

The level of the second floor is determined by using the 12" partitions as spacers between the base and the 2nd floor. With the two 12" partitions centered under the left and right edges of the 2nd floor, apply glue to the mating edges of the second floor and lower into place with openings oriented as shown. For nail locations, measure and make marks up the outside of the left side, back and right front sub-assembly up 14 3/8" from their bottom edges. Using 1" nails, nail through into the 2nd floor.

In like manner, install the 3rd floor using the 10" partitions for spacing between the 2nd and 3rd floors. The stair opening is oriented to the right and rear. For nail locations for the 3rd floor, measure and make marks up 24 7/8" from the bottom edges.

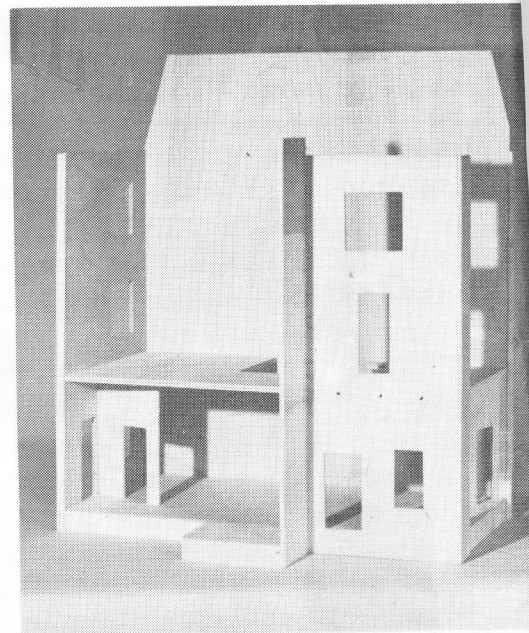
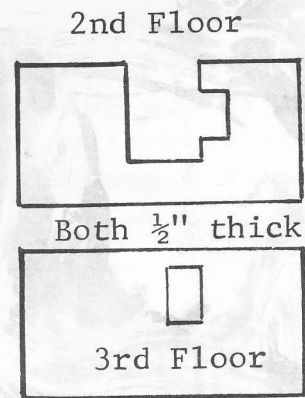

## 17. INSTALLATION OF FOURTH FLOOR

The 4th floor rests on the top edges of the left side, right front sub-assembly, and the L-strip at the right rear corner. Apply glue to the mating surfaces and set the 4th floor in place with the stair opening to the right and rear as shown.

It is very important to have the 4th floor located accurately when it is nailed into place. As a first step, hold the left edge of the 4th floor flush with the outside edge of the left side and nail using 1" nails. Then nail through the 4th floor into the top edge of the right front sub-assembly, being very sure to obtain the 3/8" overhang at the front and 3/8" overhang on the right.

Measure up and make marks along the outside of the back, 35 1/4" from the bottom edge for nail locations. Using 10" partitions as spacers to prevent sag, nail through the back into the rear edge of the 4th floor.

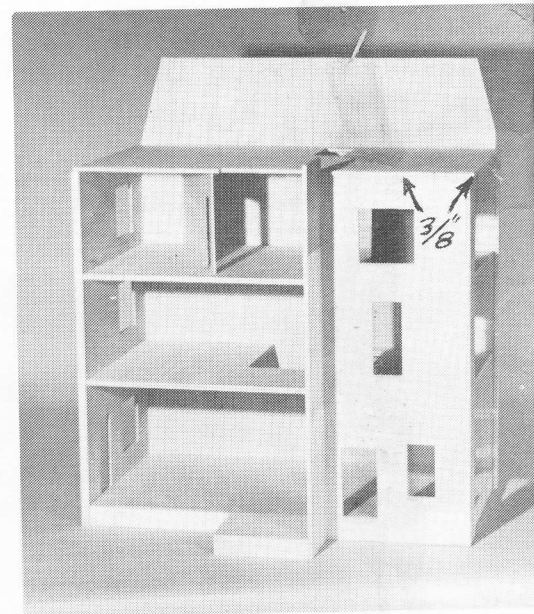
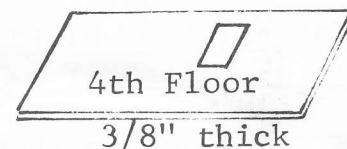

18. INSTALLATION OF:

Left Tower Side/Front Strip Sub-assembly  
 &  
 Second, Third  
 &  
 Fourth Floor Extensions

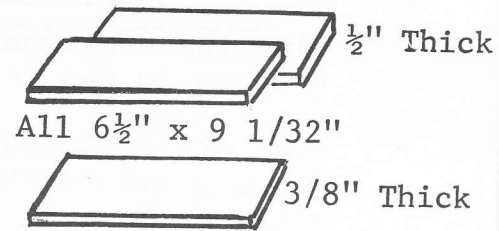

With the Left Tower/Side Strip sub-assembly in place as shown, glue and nail (1" nails) the sub-assembly to the underframe of the base only.

Using 12" partitions as spacers, (partly under the 2nd floor and partly under the 2nd floor extension) glue and nail through the Tower Sides into the 2nd Floor Extensions.

As each floor extension is installed (and the location of the left tower side is firmly determined), glue and nail through the Left Strip into the respective floors.

In like manner (but using 10" partitions for vertical spacers), glue and nail the 3rd and 4th floor extensions into place.

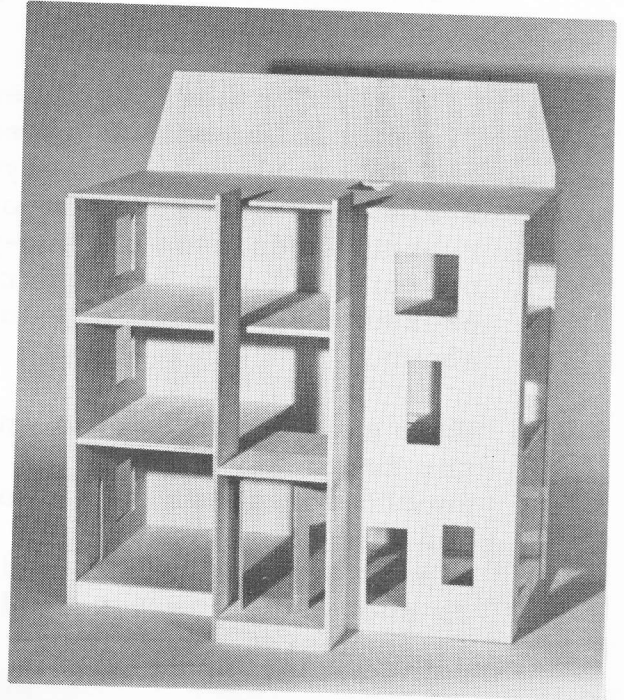

19. INSTALLATION OF UNDERMOLDING ONTO THE FOURTH FLOOR

Glue (and nail if desired) the 4 pieces of Undermolding onto the 4th floor where they fit, being careful to maintain level fits and get tight joints at the mitered corners. Weight can be used to secure molding in place until the glue is set.

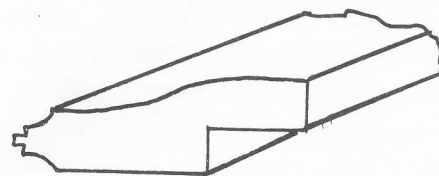

Cross section

20. INSTALLATION OF L-STRIPS AND DOOR LATCH SPACER

Glue L-Strips onto the front edge of the Tower Sides and both edges of the Tower Door as shown. Use tape or clamps until the glue sets.

The Door Latch Spacer for the Left Front Bay Door is

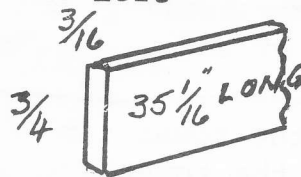

Glue in place as shown by arrow.

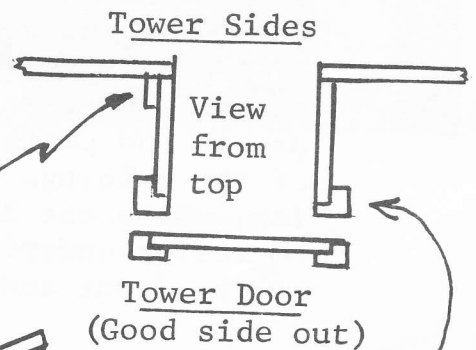

2 pcs. 36 5/8"  
 2 pcs. 34 11/16" (for TOWER DOOR)

## 21. SUB-ASSEMBLY OF TOWER TOP

Glue the rear door panel into the grooves in the tower side panels.

Glue the 4 pieces of tower ceiling molding around the 4 edges of the tower ceiling (1/4" plywood, 9 3/4" x 9 3/4"). Apply pressure with rubber bands.

Glue the 3 pieces of tower floor molding onto 3 edges of the tower floor (1/2" plywood, 9 3/4" x 9 3/4"). Some of the rubber bands used in sub-packs of this kit can be used to hold pressure on the glue joints, as shown.

When glue is set, glue and nail the tower floor onto the rear panel/side panel sub-assembly and the tower posts. To do this, place the rear panel upside down as shown and the tower floor (also upside down) on it with the tower posts under the front corners for support. Nail through the tower floor and into the side panels, being sure that the rear of the side panels are flush with the rear corners of the tower floor. Then nail through the tower floor into the tower posts with the posts snug in the protruding corners of the molding.

Set the tower assembly right side up and place the tower ceiling on top of the tower posts and side panels as shown. Glue and nail while pressing the side panels and posts into the corner of the moldings in the tower ceiling. Glue the 3 tower fascia boards up under the tower ceiling at the front and sides of the tower.

The remaining part of the tower top is to be glued between the tower sides and on top of the 4th floor extension (with 1 1/2" face outward).

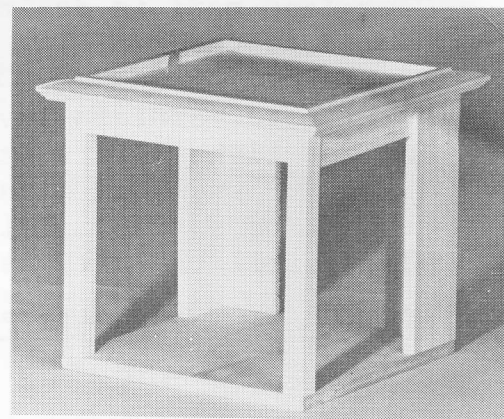
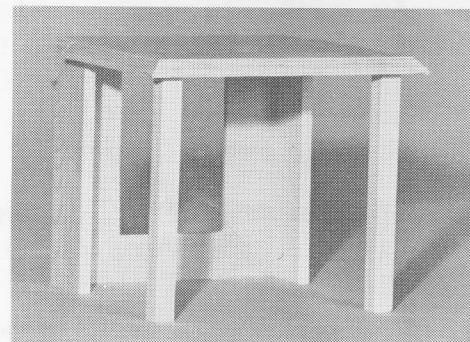
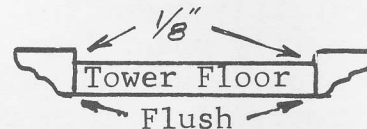
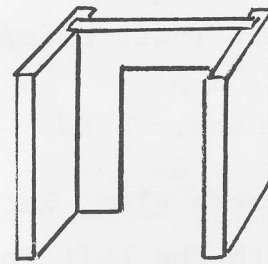

22. SUB-ASSEMBLY OF TOWER TOP CAP

The tower top cap consists of 4 panels and a square top roof. The 4 panels are all the same size, which means that each side overlaps one adjacent side and is overlapped by the other adjacent side as shown. Apply glue to the mating edges of panels and nail them together progressively, using 1/2" nails as shown. Glue the square top roof in the upper opening. Allow glue to set.

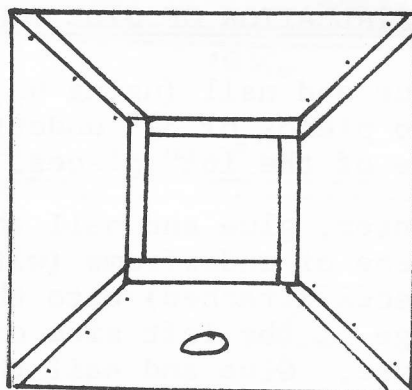

23. INSTALLATION OF:

Roof Top (from Step 12)

Left Roof Side

Right Roof Front

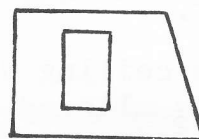
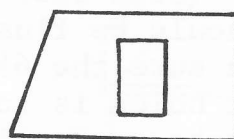

Apply glue to the grooves in the overmolding on the Roof Top and the appropriate grooves in the undermolding on the 4th floor. Also apply glue onto the top edge of the back and splice strip.

Set the Roof Top, Left Roof Side, and Right Roof Front in place as shown. With the rear edge of the Roof Top centered and flush to the outside of the splice strip, nail through the Roof Top into the splice strip on the top edge of the back.

Apply weight (books maybe) to the Roof Top and allow glue in the grooves to set.

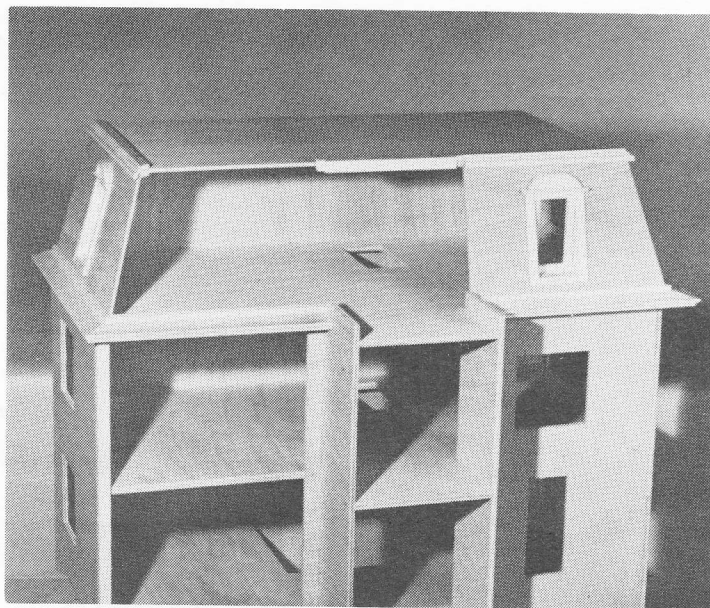

Note: The Left Roof Front and Right Roof Side are not permanently installed. They lift off for access to the top level of the house. Instructions for them later.

## 24. INSTALLATION OF SIDE PORCH

Glue and nail (using HN #1) the two pieces of  $3\frac{1}{2}$ " underframe to one of the  $16\frac{1}{2}$ " pieces.

Center, glue and nail the  $16\frac{1}{2}$ " piece of underframe (with  $3\frac{1}{2}$ " pieces attached) onto the bottom edge of the left side of the house. Glue and nail the remaining  $16\frac{1}{2}$ " underframe to the ends of the  $3\frac{1}{2}$ " pieces.

Glue the porch floor onto the underframe. (Good side of plywood up. Should be flush all around). Be sure the  $6\frac{1}{4}$ " spaces between post holes is toward front of the house - coincident with the door.

Lay the porch ceiling down with the post holes aligned with those in the porch floor. Glue and nail the porch ceiling to the house beam as shown. Glue the porch beams along the front and both ends of the porch ceiling. Allow glue to set.

Install porch posts into the holes in the porch floor and set the porch ceiling down on top of the porch posts. Be sure the porch posts are vertical and then glue and nail the house beam to the left side of the house. ( $\frac{3}{4}$ " NAILS)

Glue the center and both side roof tops in place, obtaining best possible fits at the joints.

Cut scalloped molding to fit along the front and both ends of the porch roof and glue them in place.

The porch rails are packed with their respective subpacks. Take care to retain their identity because they are not interchangeable with the tower rails or deck rails. Assembly and installation of rails will be covered later.

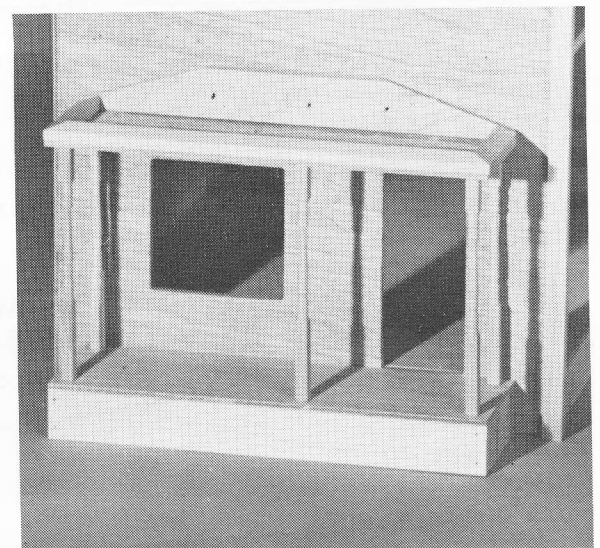
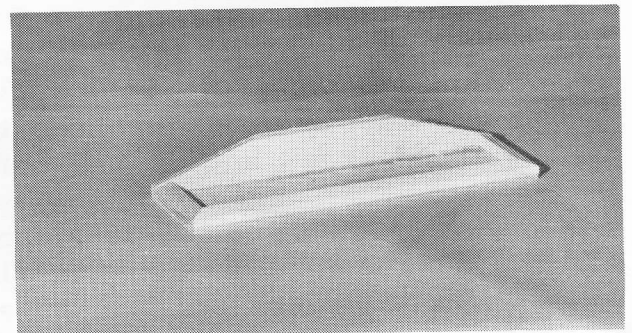
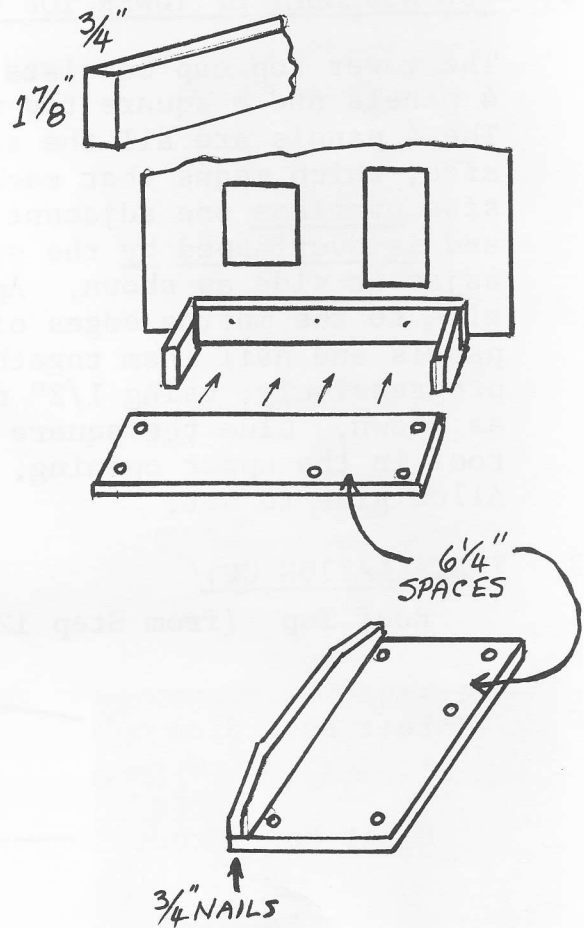

## 25. INSTALLATION OF FRONT PORCH

Using HN #1, glue and nail the underframe pieces together as shown.

When glue is set, glue and nail the sub-assembly of underframe around the right front corner of the house as shown. Complete the underframe by gluing and nailing the remaining piece of underframe in place. The remaining piece of wood ( $3/4'' \times 1\ 7/8'' \times 3/8''$ ) is for mounting the latch for the Right Side Bay Door. Glue it at the arrow.

Glue the porch floor onto the underframe (good side of plywood up). The outer edges of the porch floor should be flush with the underframe. Glue and nail the porch ceiling to the house beams as shown. Glue the porch beams along remaining edges of the porch ceiling. Allow glue to set.

Measure up 9" from the porch floor and make marks on the right front of the house. This will be the height of the porch ceiling when installed.

Install the porch posts into the holes in the porch floor and set the porch ceiling down on top of the porch posts. Be sure the porch ceiling is on the marks on the house front. Holding the ceiling snug into the corner, glue and nail the house beam to the front of the house. Glue the roof tops in place, obtaining best possible fits at the joints. Glue triangle on back of roof. Glue the scalloped molding under the roofs and along the edges of the porch beams. (See photo on front cover).

Rails for both porches are packed with the front porch. Take care to retain their identity because they are not interchangeable with the tower or deck rails. Assembly and installation of rails will be covered later.

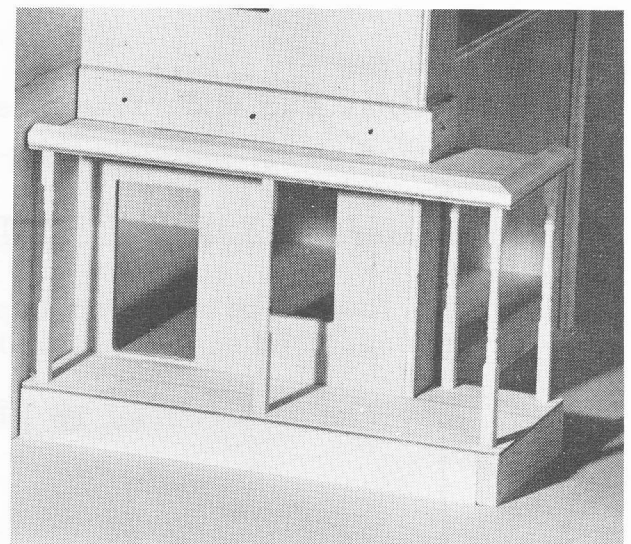
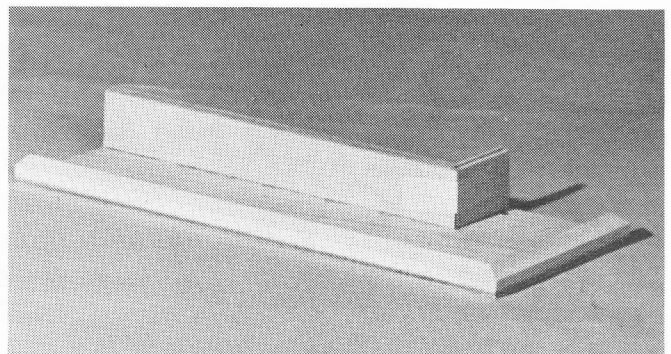
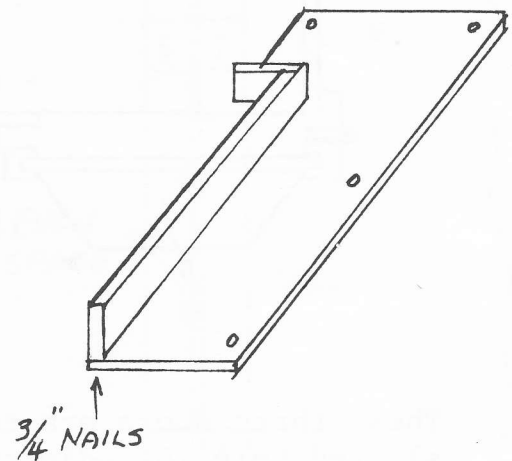
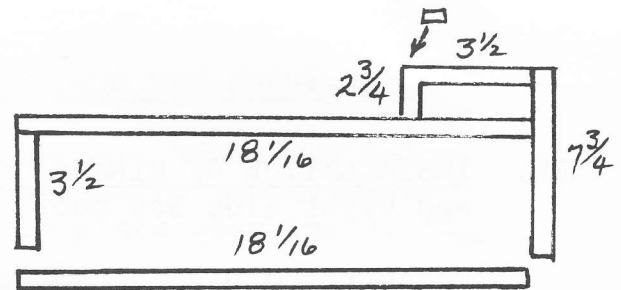



26. INSTALLATION OF HINGES ONTO: Tower Door, Left Front Bay Door, and Right Side Bay Door.

Exaggerated Diagram shows the hinging and swinging arrangement.

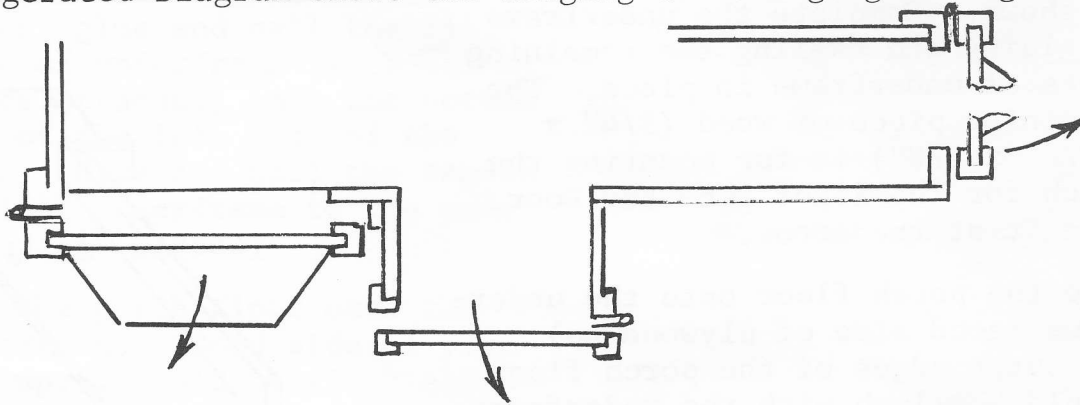

These three doors are to be hung by 3 hinges. One hinge has a slotted hole for adjustment, the other two without slotted holes.

Pilot holes for screws should be drilled  $3/32''$  diameter,  $1/2''$  deep.

Install the hinge with the slotted holes 2" from the top of doors with the hinge pins just beyond the edge of the door as shown.

Install the second and third hinges (no slotted holes) centered and 2" from the bottom respectively.

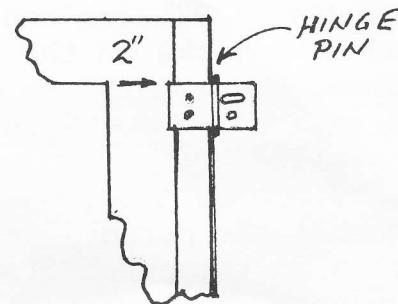

27. INSTALLATION OF FRONT AND SIDE PORCH STEPS

Set (or glue if desired) Front and Side Porch Steps in place against the underframe as shown in the photograph on the front cover.

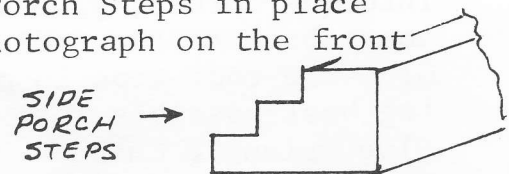

28. INSTALLATION OF TOWER TOP

The Tower Top and Top Cap are intended to simply set in place on top of the 4th floor level of the tower.

They can be secured in place if desired.

29. INSTALLATION OF TOWER DOOR AND BAY DOORS ONTO THE HOUSE

Hold the Door in place and split the clearance above and below the door by setting a thin spacer (a table knife maybe) under the door. Be sure the Front Steps are in place when installing the Tower Door.

The general technique here is to install one screw in the bottom hinge - and one screw in the center of the slot in the top hinge (no screws in the center hinge - not shown in diagrams). Then swing the door shut into the opening. If the clearances at the bottom and top of the door are not equal, the door is not exactly plumb (vertical).

Adjustment is made by shifting the slotted hinge in or out to make the clearances even.

Bullet latches are provided to hold the two bay doors closed. A bullet latch consists of a spring loaded ball and an indented "strike". To install the bullet, drill a  $3/8\frac{1}{2}$ " diameter hole in the edge of the door and insert the bullet. Mounting in the lower door in the vicinity of the underframe provides the most rigid mounting. Close the door and note where the protruding ball makes contact with the spacer. Install the strike so that the ball contacts the indentation as it closes. After the door and latch operate smoothly, install all the remaining screws in the hinges.

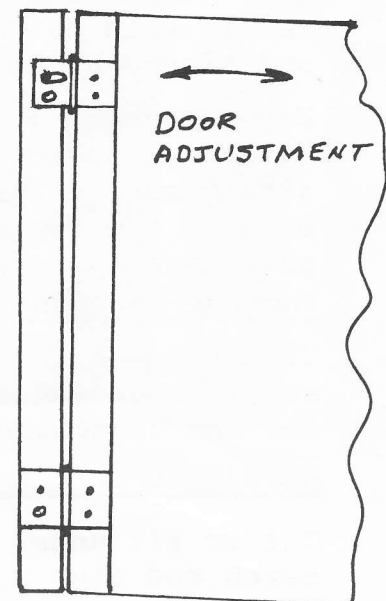
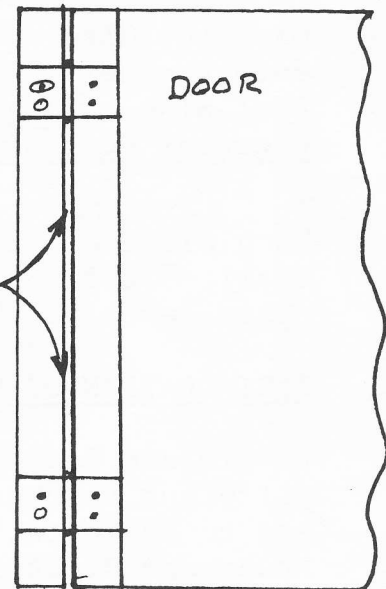

30. SUB-ASSEMBLY OF FIRST FLOOR STAIRWAY LANDING

Glue the two landing supports into the grooves in the landing as shown.

Provide support to keep the supports vertical while the glue sets. Then glue the balusters and handrail into the pre-drilled holes as shown.

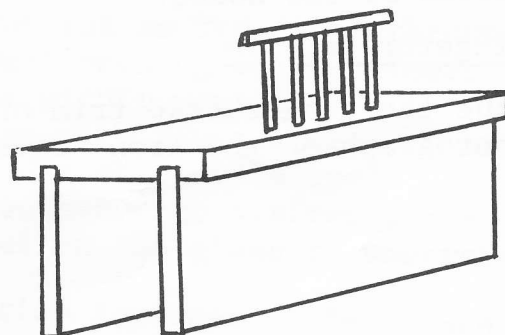

31. SUB-ASSEMBLY OF OVERMOLDING AND OUTSIDE CORNER MOLDING ONTO LEFT ROOF FRONT AND RIGHT ROOF SIDE

Refer to the diagram in Step 12 and the photo in Step 23. Set the Left Roof Front and Right Roof Side in place and glue the overmolding ( $b_1$  and  $b_2$  from Step 12) to the Roof Front and Roof Side. No glue on the Roof Top. Use weights to hold pressure until the glue sets.

Glue the mitered outside corner molding onto the Left Roof Front and Right Roof Side. No glue on the adjacent edges of Roof Side and Roof Front.

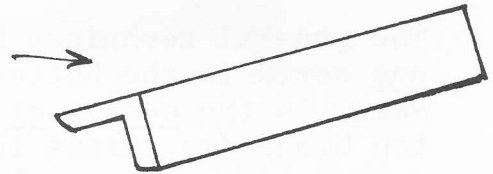

Approximately 9" long

Each piece of the outside corner molding is cut so that, when installed, the roof sections can be lifted off for access to the upper level of the house.

32. INSTALLATION OF HOUSE TRIM

Fascia and Bead Trim are provided in two different thicknesses. The thick pieces are to be installed on the Left Side, Right Front and Right Strip of the house. Thin pieces go at the top of both Bay Doors. Cut the fascia and bead trim to fit and glue at the top of the third floor level, with thick and thin pieces positioned as above.

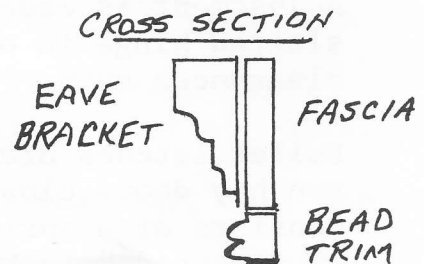

Eave brackets are glued onto the Fascia as shown. If the paired arrangement is used as shown, spacing between the two is  $1/4$ ". Space the pairs evenly on each Fascia.

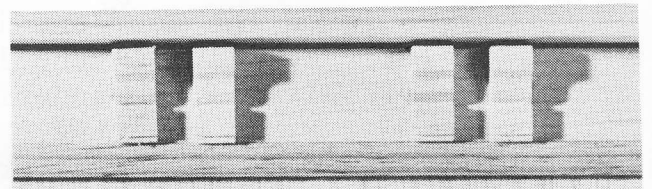

Top Bay and Scallop Molding

Glue top molding and cut and glue scallop molding around the top of the bay windows as shown.

Outside Corner Molding

Cut to fit under and over the front porch and glue onto the right front corner of the house.

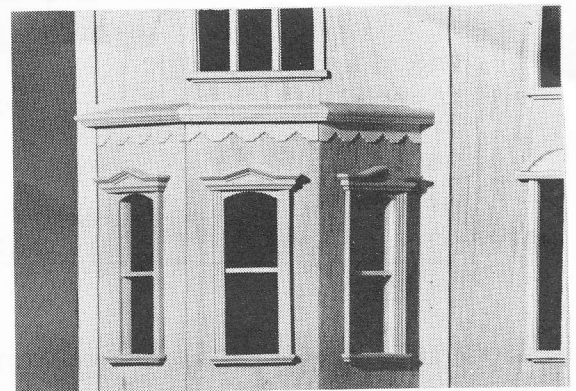

Gingerbread Trim

Glue the gingerbread trim onto the Tower Top as shown in the photograph on the front cover.

### 33. INSTALLATION OF DOORS, WINDOWS AND EXTERIOR WINDOW TRIM

- a. Four prehung doors are glued in place from the exterior. Be sure the tower door is mounted up far enough in the opening to have clearance above the steps. Interior door trim may be installed at this point - or delayed for wall-papering.
- b. All the windows are glued from the interior. Masking tape will hold them secure. Cut the lengths of window pane dividers to length - for a tight wedged fit between the window side frames.
- c. Exterior window trim is glued around the windows as shown.

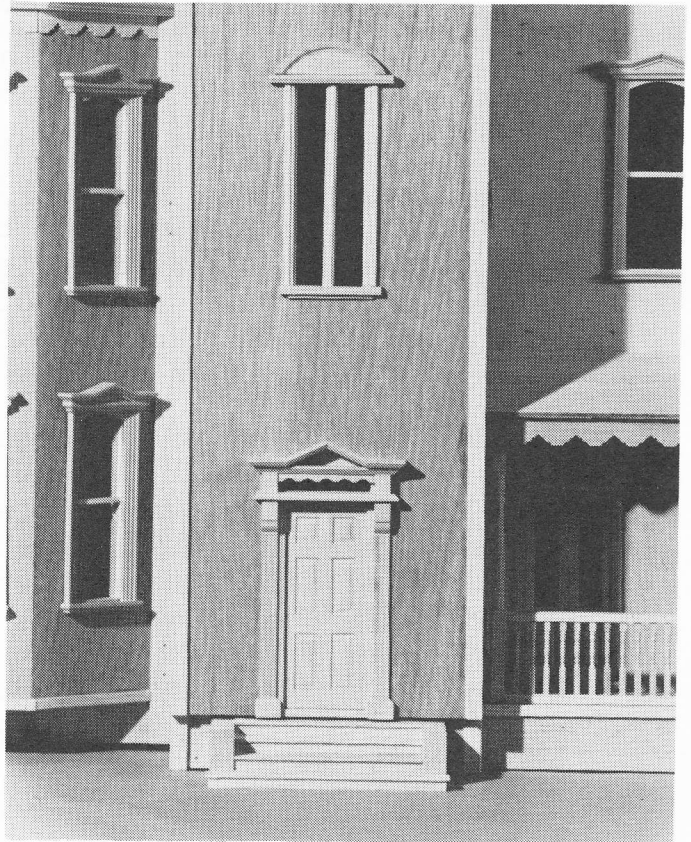

The cross section of the Window Lintels:

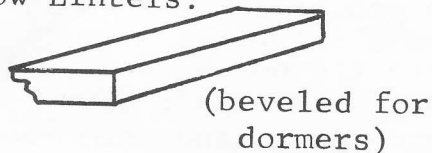

The cross section of the vertical frames:

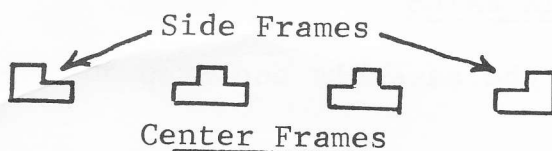

Separate facing strips are provided to be glued under the window sills. →

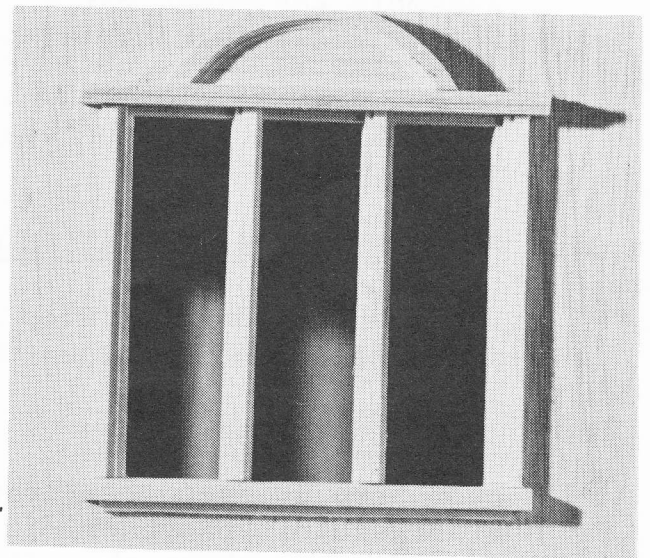

### 34. INSTALLATION OF PARTITIONS

- 2 ea. 11 1/8 x 22 1/2 - Vertially from 1st to 3rd floor through large stairwell opening in 2nd floor.
- 2 ea. 8 x 12 - On first floor in line with tower sides.
- 2 ea. 8 x 10 - On second floor in line with tower sides.
- 2 ea. 10 x 19 - On third floor, one adjacent to stairwell
- 1 ea. 8 7/8 x 10 - On fourth floor. adjacent to stairwell - and with spacer channel on top glued to underside of roof top.
- 1 ea. 10 x 13 1/2 - A bathroom partition for rear of left, 3rd floor. A facing channel is provided for the exposed edge.



35. ASSEMBLY AND INSTALLATION OF THE ROOF DECK RAILS

First select pairs of top and bottom rails and orient them to obtain matched spacing of the holes.

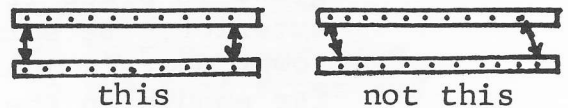

The Baluster Pegs are square-cut on one end, blunt pointed on the other. Just touch the square end of the pegs into a small puddle of white glue and insert them into the holes in the top rail.

Pick up and invert the assembly and just touch the pointed end of each baluster in the glue puddle - and then, retaining the matched orientation of holes, lower the bottom rail onto the pointed ends of the balusters. Tap the bottom rail down snug on the spacer and adjust as necessary to obtain square ends.

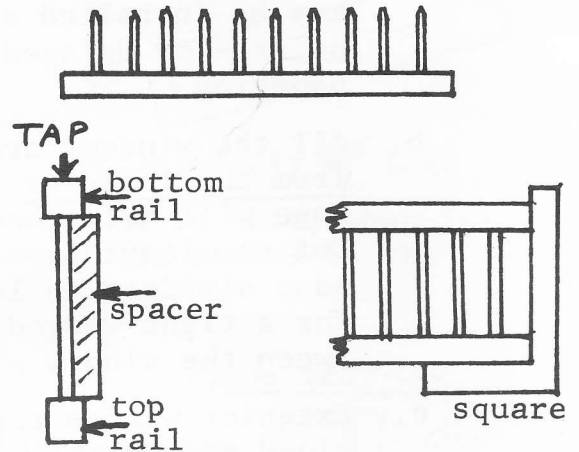

36. ASSEMBLY AND INSTALLATION OF PORCH RAILS

Assemble the porch rails using the procedure of Step 35 above. Spacer not required, balusters have shoulder. When glue is set, cut to fit between the porch posts. It is best to cut slightly long and use sandpaper to adjust down to a snug fit. Glue in place between the porch posts and onto the porch floor.

37. ASSEMBLY AND INSTALLATION OF TOWER RAILS

Use the procedure of Step 35 for the assembly and Step 36 for the installation of the Tower Rails.

38. INSTALLATION OF STAIRS

From Step 30, set the First Floor Stairway Landing on the first floor against the back of the house. Place the remaining stairs according to where they fit. The stairs slip into place from below. The top landing fits over the floor above. Glue is optional. The landing L-rail is to be placed around stairwell on 4th floor.

39. INSTALLATION OF FACING STRIPS

Lengths of facing strips (1/2" and 3/8" wide) are provided to cover all remaining exposed edges of plywood. The 3/8" width is to be used at the edges of the porches and the bottom edges of the bays - as well as on 3/8" plywood edges. Cut the longest lengths needed first (such as the inside of the bay openings) - and the shorter lengths from remainders.

The purpose of this package of facing strips is to close the spaces between the floors of the house and the doors - the bay doors and the front tower door.

Glue the facing strips as shown in diagram below

These facing strips will close the spaces except for the thickness of the hinges. To close completely, the hinges can be mortised.

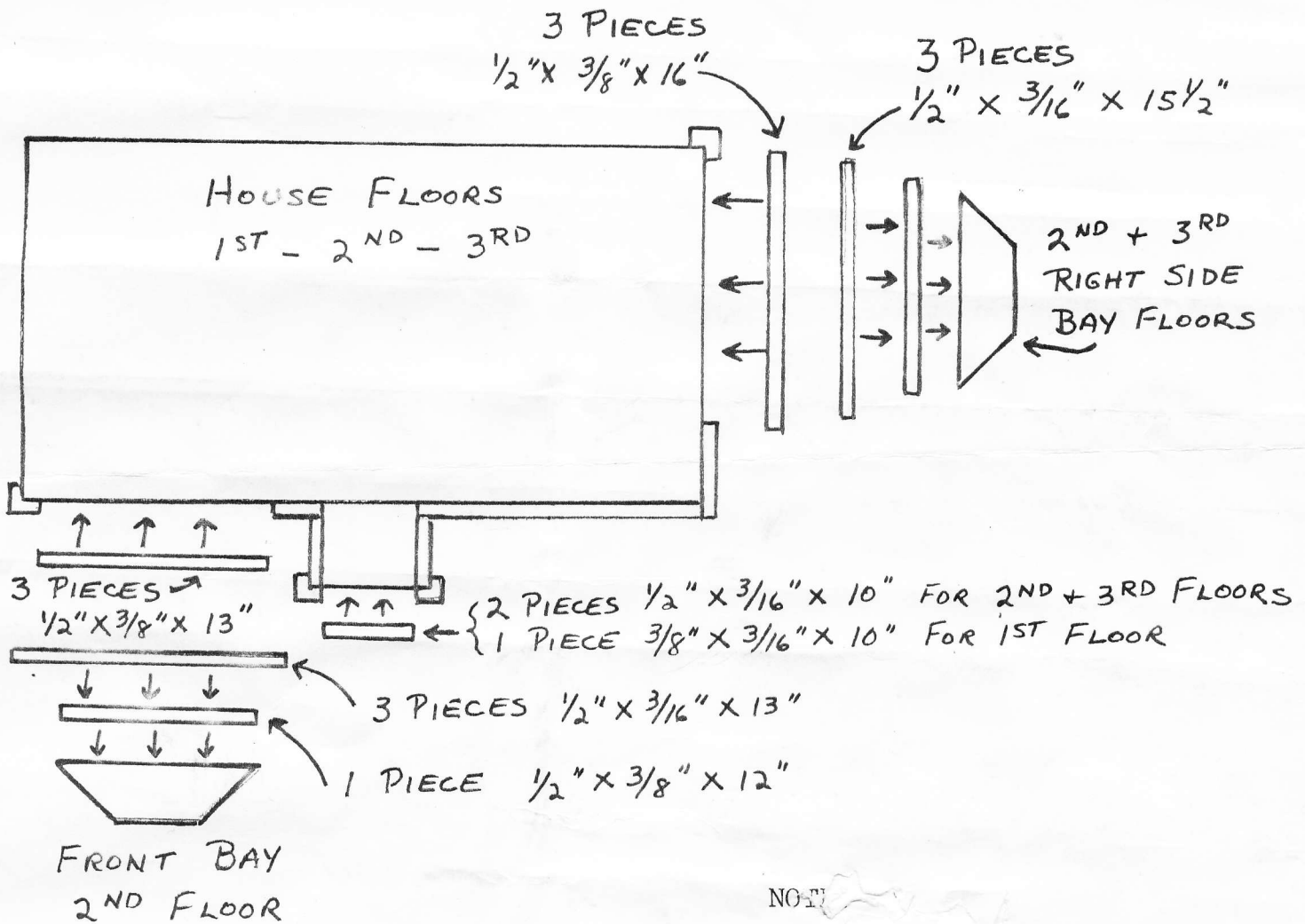

NOTE

Cut individual facing strips to length for accurate fit.

## BAY MANSION FACT SHEET

The Photography of the Bay Mansion is NOT worth a thousand words—people who have seen the real thing say the pictures fall far short—“Magnificence-wise.” Hopefully, additional words will convey a more accurate visualization. First, how large is it really?

57” to the top of the tower 48” wide—including the porches 25” deep—(not including front steps)

### The main features:

- STURDY CONSTRUCTION—3/8” EXTERIOR WALLS
- 10” CEILINGS
- STANDARD WINDOW AND DOOR OPENINGS
- LARGE ROOMS—LIKE 19” X 14”
- TURNED PORCH POSTS AND BALUSTERS
- TASTEFUL APPLICATION OF GINGERBREAD
- ALL STAIRS PRE-ASSEMBLED (5 SETS)
- OPTIONAL WORKING OR NON-WORKING WINDOWS
- INTERIOR DOORS NOT INCLUDED—OPENINGS ARE STANDARD
- OPTIONAL SIDING PACK TAILORED TO THE BAY MANSION

The Bay Mansion Kit can be assembled and shipped built-up from the factory—call for quote.

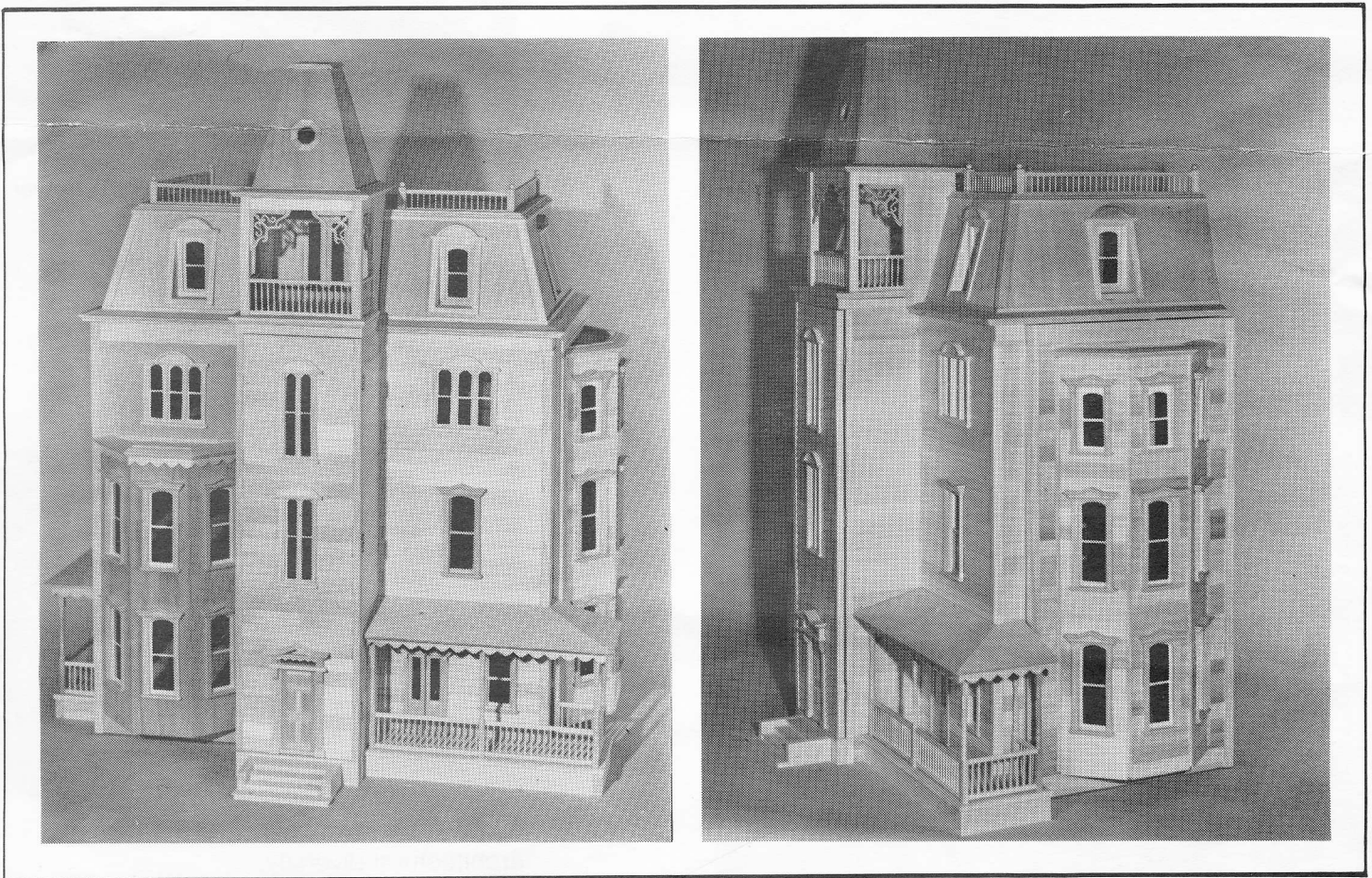

**#520 The Bay Mansion.** All dollhouse collectors will appreciate the value of this magnificent Victorian creation. A very spacious floor plan allows for 10-12 rooms,

depending on the partition arrangement. Kit complete with doors, framed plexiglas windows, exterior window trim units, all staircases, railings and decorative trim.

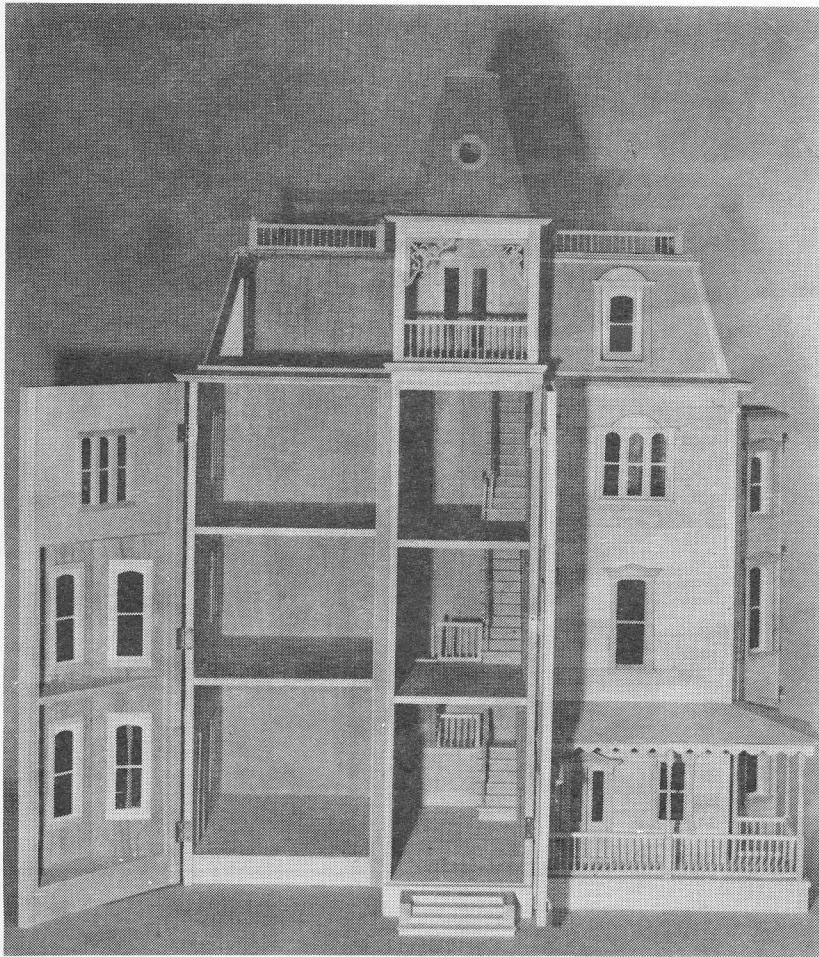

Most versatile room arrangements are possible by access openings on front and side. Authentic bay windows are trimmed in scaled moldings and trim. Large rooms throughout our Bay Mansion give your customers maximum decorating flexibility.

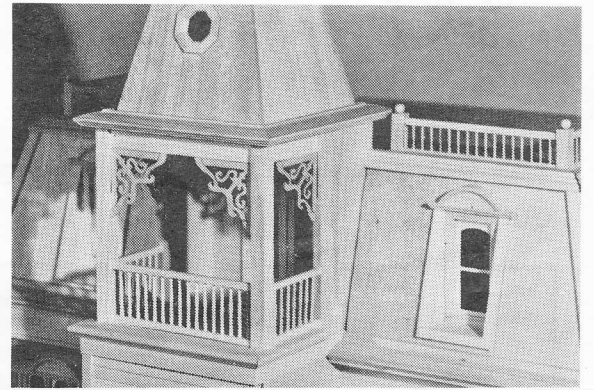

Unique scaled dormer window treatment accent the dominance of the center tower.

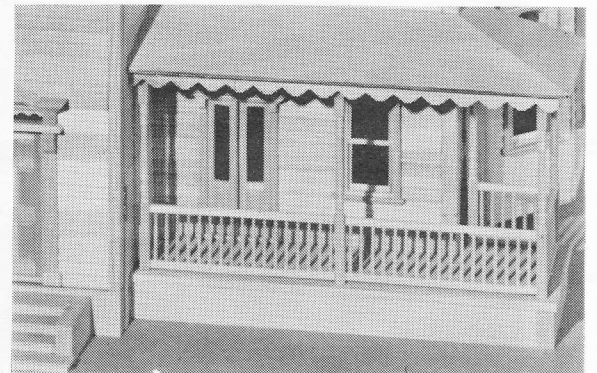
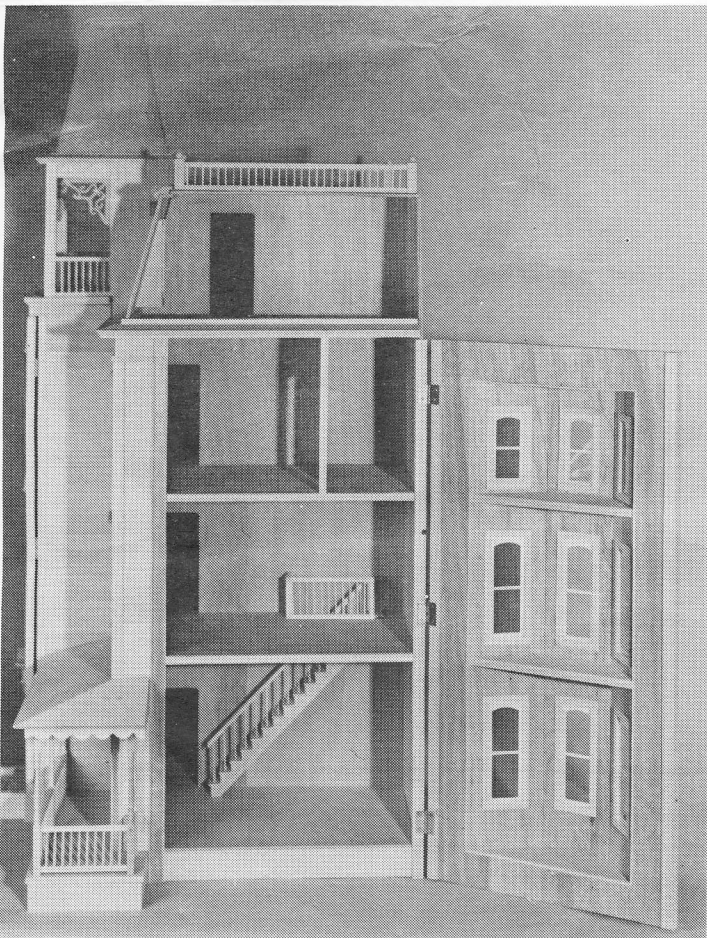

Porches and balconies add interesting architectural diversity.

**Walmer Doll Houses**  
2100 Jeff Davis Highway  
Alexandria, VA 22301  
800-336-0285  
703-548-8804