

VICTORIAN DOLLHOUSE KIT

Model DH-71K

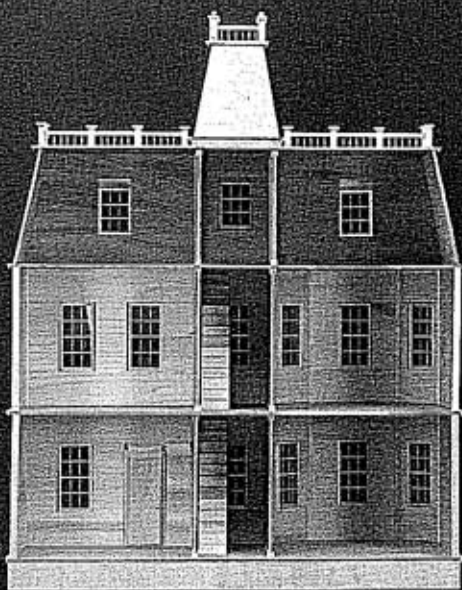

- All Wood
- Adjustable room sizes
- Pre-cut parts
- No tools - only glue required
- Windows, stairs, door and porch trim included
- Interlocking tongue-and-grooved walls for easy assembly
- Scale: 1" to 1'
- Dimensions:
32"L x 16"D x 42"H



Very Early Version
Mid 1970s?



DIVISION OF
HARVARD TABLE TENNIS, INC.

Patrie Dollhouses

970 FELLSWAY • P.O. BOX A • MEDFORD, MASS. 02155 • (617) 396-8080

**Early Version
(early '80s)**

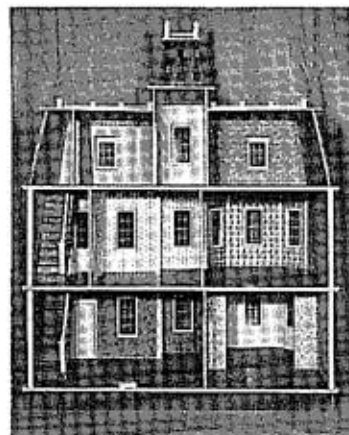
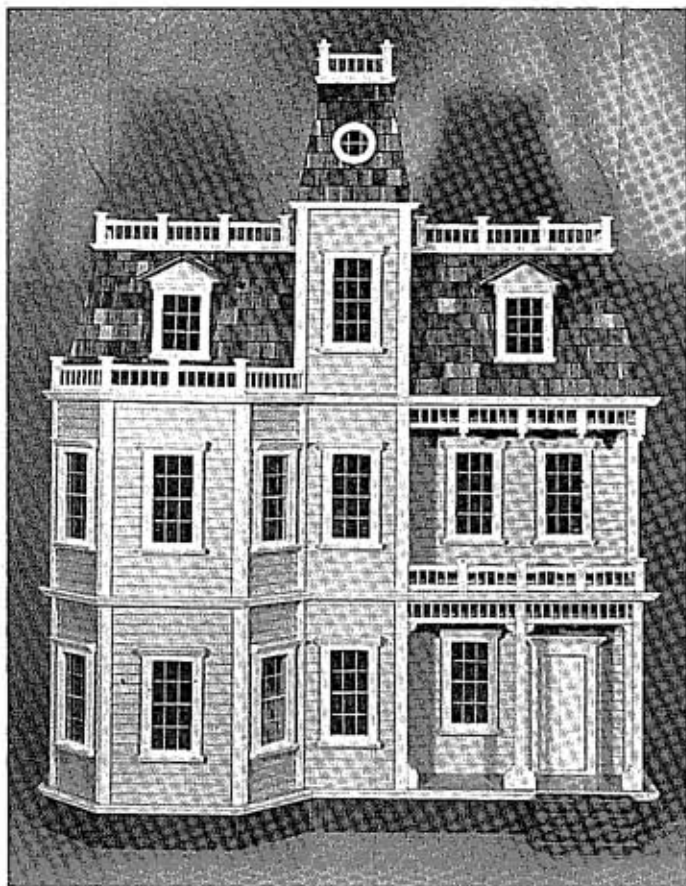

BATRIE DOLLHOUSES

Model No: DH- 71K
Dollhouse Kit

ASSEMBLY INSTRUCTIONS

Refer frequently to the photograph of the completed dollhouse on this page to aid you in assembly.

1) INTRODUCTION

Congratulations on your purchase of a Batrie Dollhouse.

Your dollhouse has been precision crafted in Massachusetts with meticulous care by our Yankee Craftsmen using only the finest quality materials.

Take your time during assembly and be sure to read the instructions completely before you proceed.

This dollhouse will last for years, even generations, if proper care and attention is given during assembly.

2) HELPFUL HINTS

Always read through all assembly instructions before assembling the house.

Do not skip steps. Follow the instructions in the defined sequence.

- a) Arrange pieces in groups ready for assembling. Following the assembly instructions, assemble enough in a dry run to be sure you know ahead of time when and how each part fits. Always be sure of the parts orientation before gluing.

- b) Sand any rough edges or splinters before gluing.
- c) Use generous amounts of glue. Always wipe off excess glue immediately.
- d) Make all joints flush. Keep surfaces and edges square.
- e) Occasional changes in humidity can cause all woods to expand or contract slightly. Always "dry-fit" parts before gluing. Limited sanding or clamping may be required for proper fit.
- f) All Batrie dollhouse kits are inspected before shipment. However, climatic changes and handling during shipment may cause defects.

If this occurs and there is sufficient time for us to replace the part, please contact our Service Department for replacement. (Address on next page)

Be sure to include explicit identification and measurements for the replacement part.

Most repairs can easily be made by the kit builder using either white glue or plastic-wood filler and sandpaper.

Warped parts are usually self-straightening during assembly.

- g) A large, clutter-free, well lighted work area is most helpful during assembly.
- h) Before you begin to assemble the dollhouse, it will be helpful to have the following materials handy:

White glue (Elmers)
Elastic Bands
Masking Tape (2+ inches wide)
Sandpaper (Medium grit)
Pencil
Ruler

- i) It will be necessary to use weights when gluing to insure proper adhesion and minimize slippage. Books or other flat household objects work very well as weights in these situations.
- j) Read the instructions carefully, look at the illustrations and photograph on the front cover; and think the assembly through before you proceed.

TAKE YOUR TIME

NOTE:

For the fastest replacement of shortages or broken parts, write direct to Batrie Dollhouses.

Batrie Dollhouses
Service Department
P.O. Box A
Medford, MA 02155

3) The first step is to identify and familiarize yourself with all the items in the kit. Figure 1 identifies the major plywood parts in the kit.

(Not shown are the plywood foundation parts and stair risers).

4) The kit also includes the following parts separately bagged for your convenience.

- a) 12 Large Window Kits
(Refer to page 27, 28, 29)
- b) 2 Dormer Window Kits
(Refer to Figure 11 and 11A)
- c) 1 Round Window Kit
- d) 1 Door Kit
(Refer to page 30 and 31)
- e) 2 Die Cut Interior Stair Kits
(Refer to page 32)

- f) 1 Die Cut Front Stair Kit
(Refer to page 33)
 - g) Railing Trim Kit
(Refer to Figure 14)
 - h) Edge Nosing Kit
(Refer to Figure 18 and 19)
 - j) Exterior Trim Kit
(Refer to Figure 14, 15, 16, 17)
- 8 wooden balls
4 large eaves bkts.
6 small eaves bkts.
2 long porch posts
26 short porch posts
22 post caps

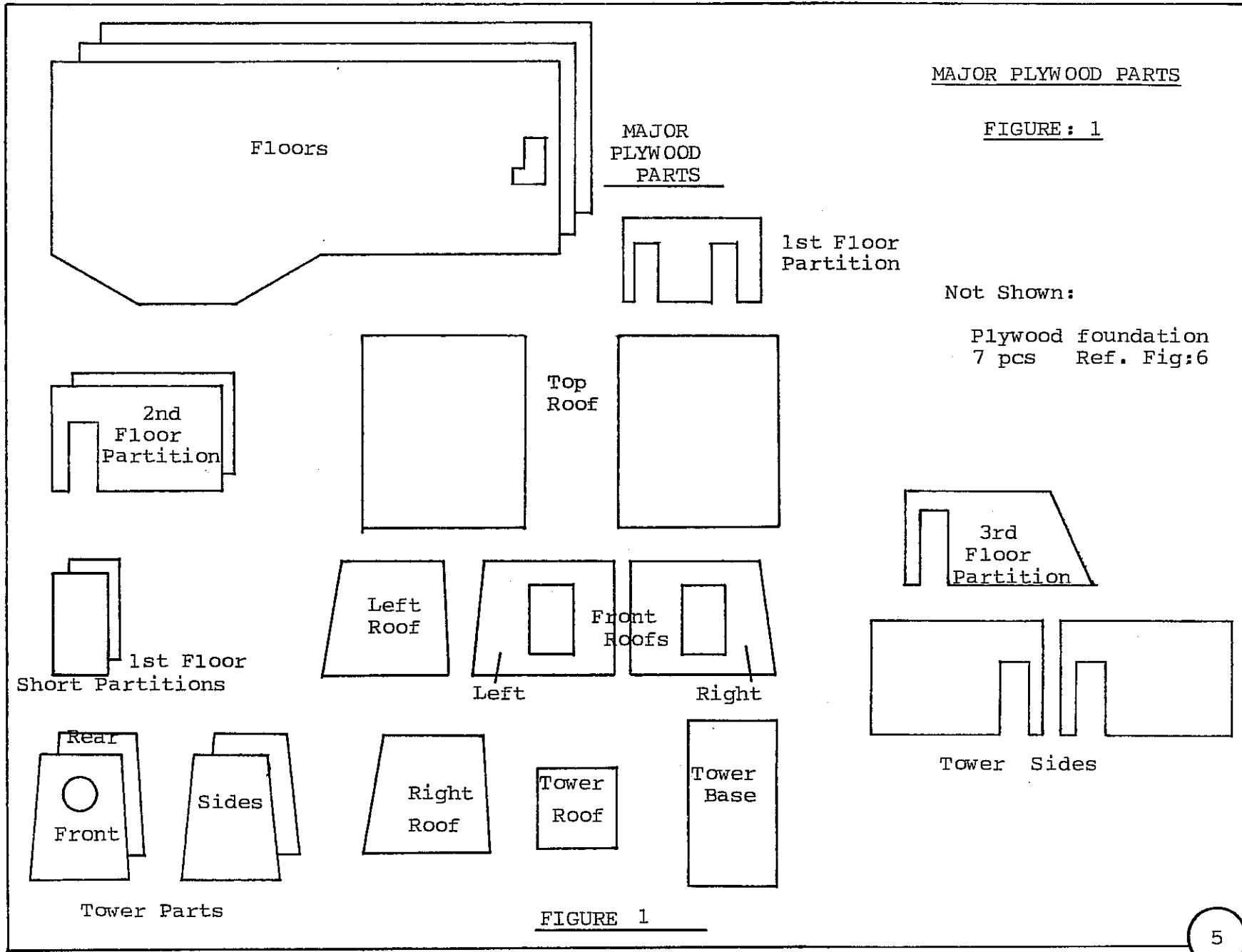

FIGURE 1

5) Figure 2 illustrates the clapboard siding pieces required to build the 1st and 2nd floors of the dollhouse.

<u>Piece</u>	<u>Qty.</u>	<u>Length (in inches)</u>
A	2	6 - 16/32
A1	2	6 - 16/32 (no tongue)
B	2	5 - 4/32
B1	2	5 - 4/32 (no tongue)
C	4	4 - 2/32
C1	4	4 - 2/32 (no tongue)
C2	16	24/32
D	6	2 - 16/32
D1	2	2 - 16/32 (no tongue)
F	8	1 - 8/32
G	1	12 - 8/32
G1	2	12 - 8/32 (no tongue)
H	10	2 - 11/32
I	1	7 - 8/32
J	11	1 - 30/32
P	6	12
P1	2	12 (no tongue)
Q	6	15 - 24/32
Q1	2	15 - 24/32 (no tongue)

The tower clapboard parts are shown in Figure 12 and include:

<u>Piece</u>	<u>Qty.</u>	<u>Length</u>
B	1	5 - 4/32
B1	1	5 - 4/32 (no tongue)
F	4	1 - 8/32

Level 2

CLAPBOARD SIDING LAYOUT DIAGRAM

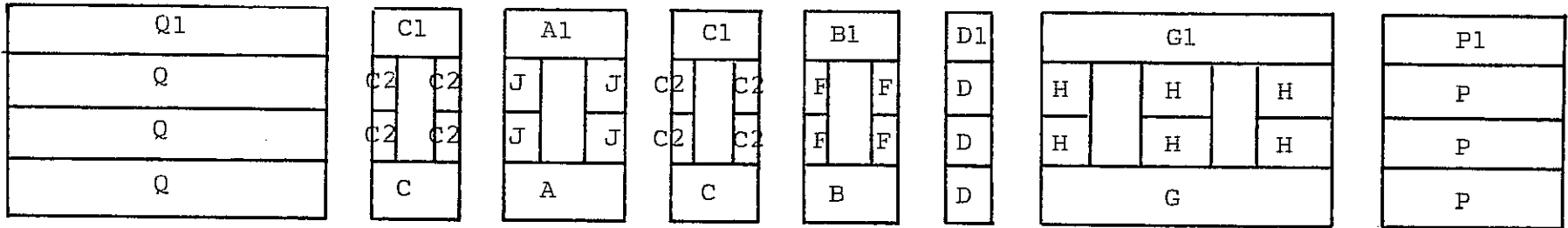

Section A.....B.....C.....D.....E.....F.....G.....H

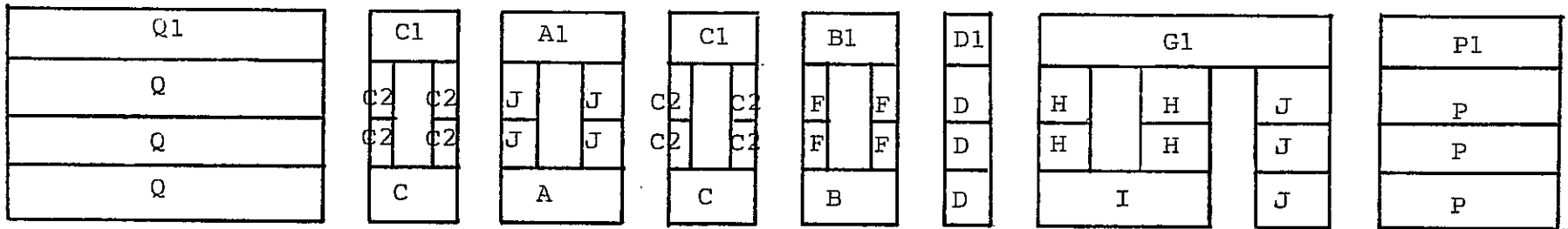

Level 1

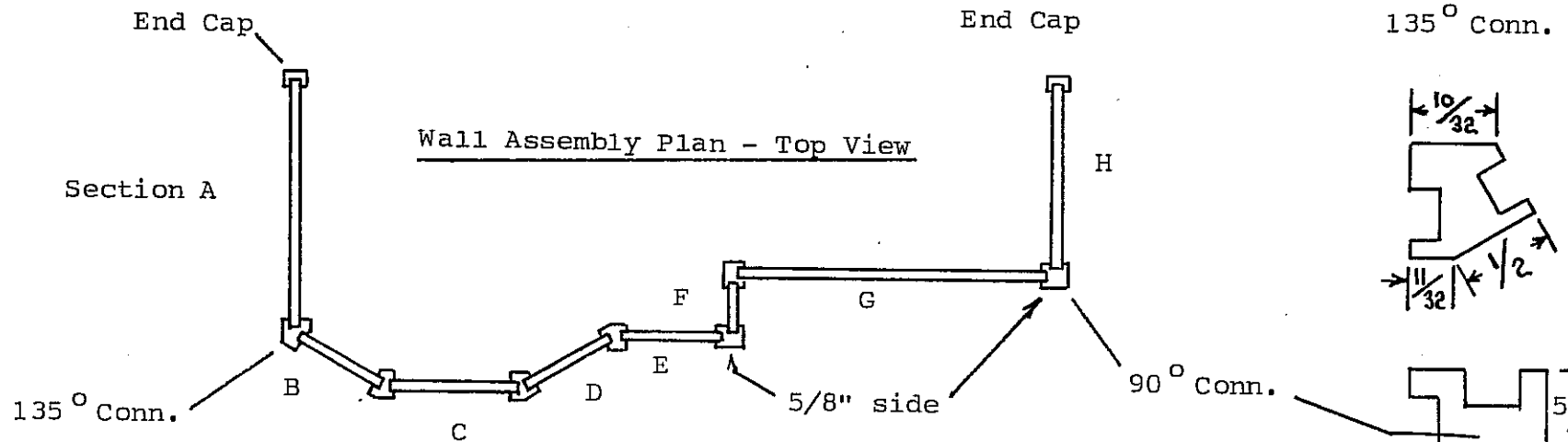

SPECIAL NOTE: 90° Corner Connectors must be installed so that the 5/8" side faces forward.

FIGURE: 2

- 6) We will now build up the walls for the first level of the dollhouse.

Identify and arrange the siding for the 8 walls of the first level (Sections 1-A through 1-H) Per Figure 2.

Without glue, dry-fit clapboard siding pieces to make sure that they interlock without interference.

NOTE: The clapboard siding pieces without a tongue are always installed at the top of a wall section. Sand any protrusions to make sure the siding fits properly.

- 7) After you are satisfied that the siding will interlock properly, you are ready to glue up the wall section.

Start with section 1-A, per Diagram 3 and glue the siding together by running a bead of white glue into the groove end of the pieces and pressing the tongue ends of adjacent pieces into position.

NOTE: The siding pieces without a tongue must be positioned at the top of the section.

Push the siding pieces together on a flat surface applying weight and side pressure as required to make a tight joint.

It is important that the ends of the siding are square and flush.

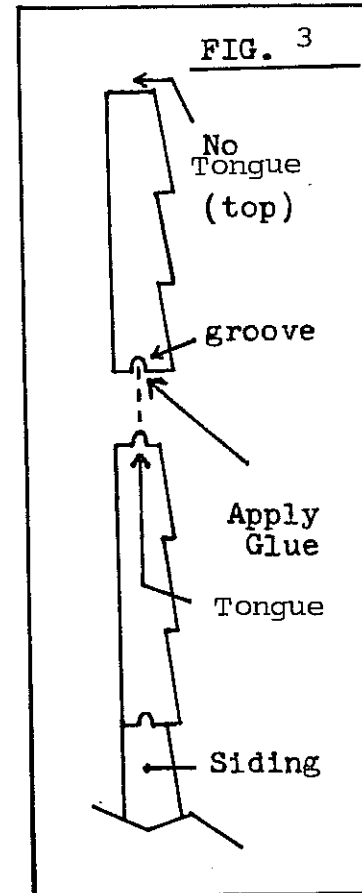

Place the sections on a flat surface and weight with books or similar

objects until the glue sets.

- 8) Complete the remaining wall sections (1-B through 1-H) for the first level of the house. Be sure all windows and door openings are positioned as shown in Figure 2 .
- 9) The next step is to install the corner connectors to the built-up wall sections of the first level.

Clean the ends of the wall panels removing excess glue and any protrusions that may occur to make sure the panels will fit into the corner connector grooves.

Orientate wall section 1-A so that it is clapboard siding side face-up with the Q1 siding piece (without tongue) at the top.

Apply a bead of glue to the groove of a long 1-way connector and install it to the left side of section 1-A
Refer to Figure 4 .

- 10) Next, install a 135° corner connector to the right side of section 1-A. Refer to Figure 2 .

NOTE: It is important that the corner connectors be installed per the drawing in Figure 2 . Be particularly careful that the dimensioned faces of the connectors are in accordance with the drawing.

In this case, the 1/2 inch face of the 135° corner connector must face up for it to be properly installed.

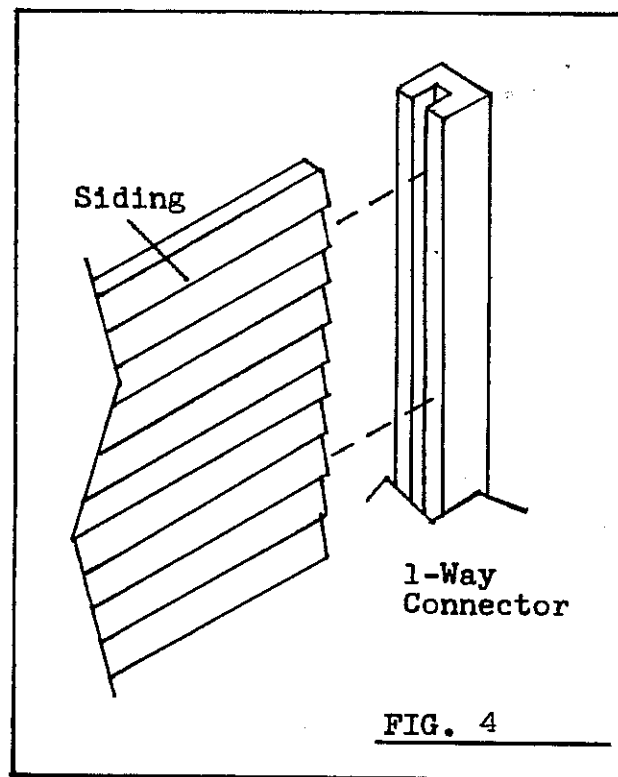

- 11) Install the remaining corner connectors as follows:
 - a) A 135° corner connector to the right side of section 1-B.
 - b) A 135° corner connector to the right side of section 1-C.
 - c) A 135° corner connector to the right side of section 1-D.
 - d) A 2-way connector to the right side of 1-E.

- e) A 2-way connector to the right side of 1-F.
- f) A 2-way connector to the right side of 1-G.
- g) Finally, a 1-way connector to the right side of 1-H.

12) The final step in building up the walls of level 1 is to interlock the wall panel sections together as in Figure 5.

Again, apply a bead of glue to the groove of the open end of a connector and slide the siding section into the connector. Make sure the section fits snugly into the connector and is flush at the bottom.

Refer to Figure 5 and interlock all the wall sections of level 1 so that when you are completed you will have a complete clapboard siding shell for level 1.

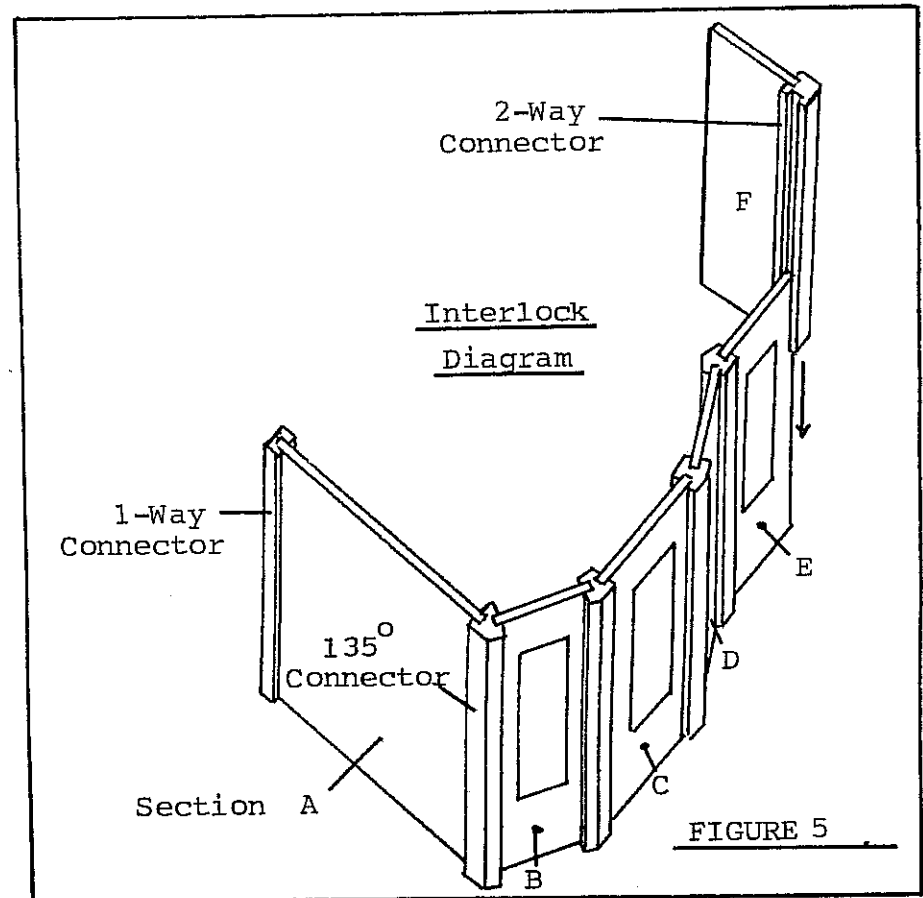

13) Using the procedures outlined in steps 6 through 12, assemble the clapboard siding shell for level 2.

14) In this section we will install the foundation to the plywood base.

The plywood base is the floor without a stairwell.

Be sure and position the base upside down as in Figure 6.

Dry fit the foundation pieces around the perimeter of the floor as in Figure 6.

After everything is properly positioned go ahead and glue the pieces in place as shown in Figure 7.

If desired, the installation of the floor can be further secured by nailing the floor to the foundation.

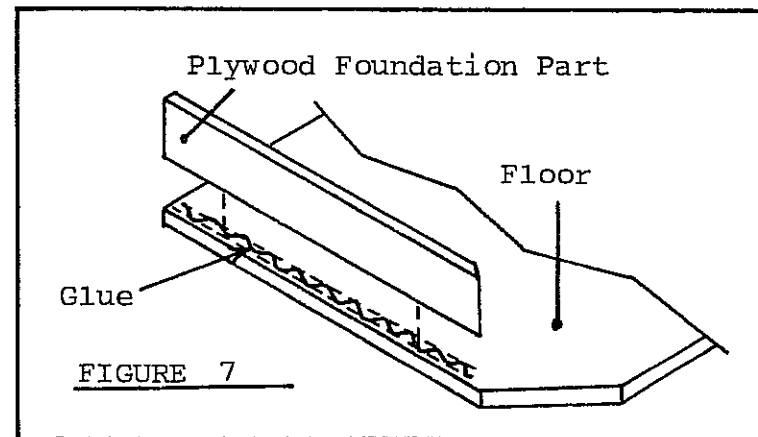
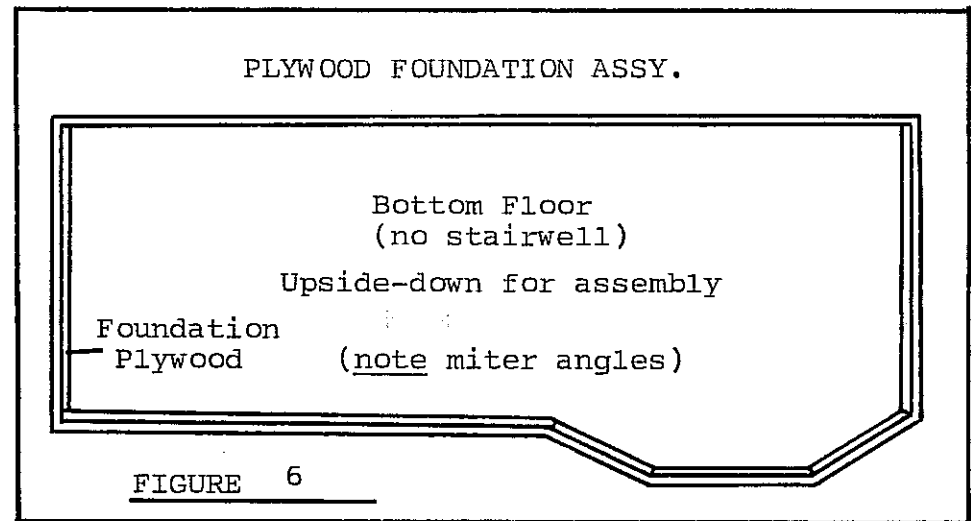

15) Attach level 1 to the base.

Arrange the assembled level 1 to the base so that the rear corner connectors are even with the back of the base.

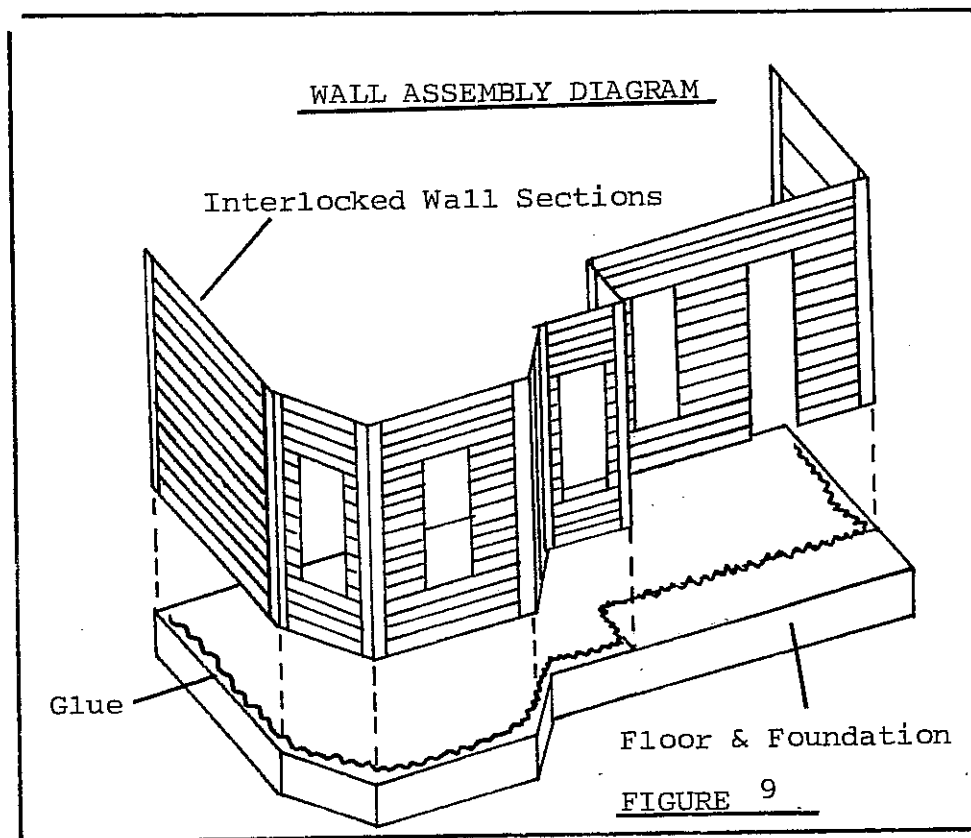
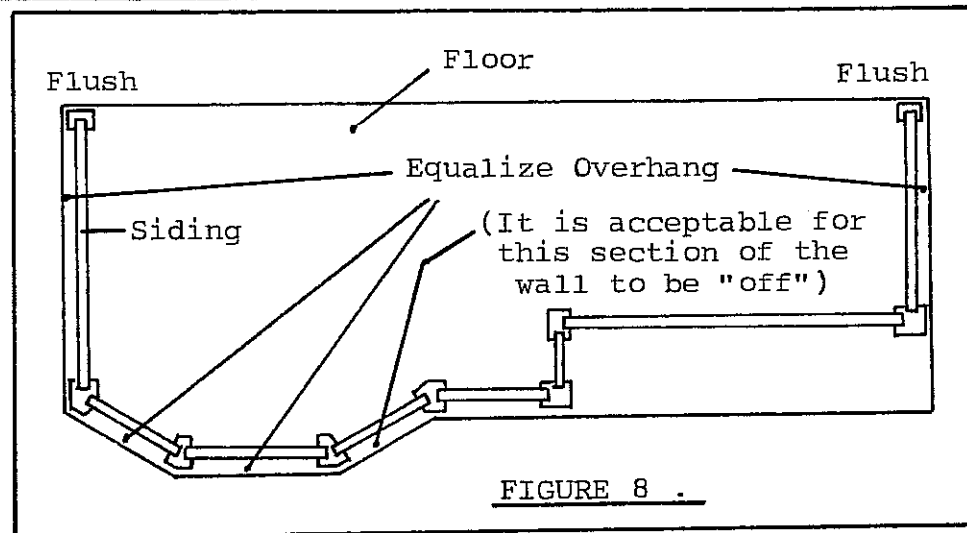

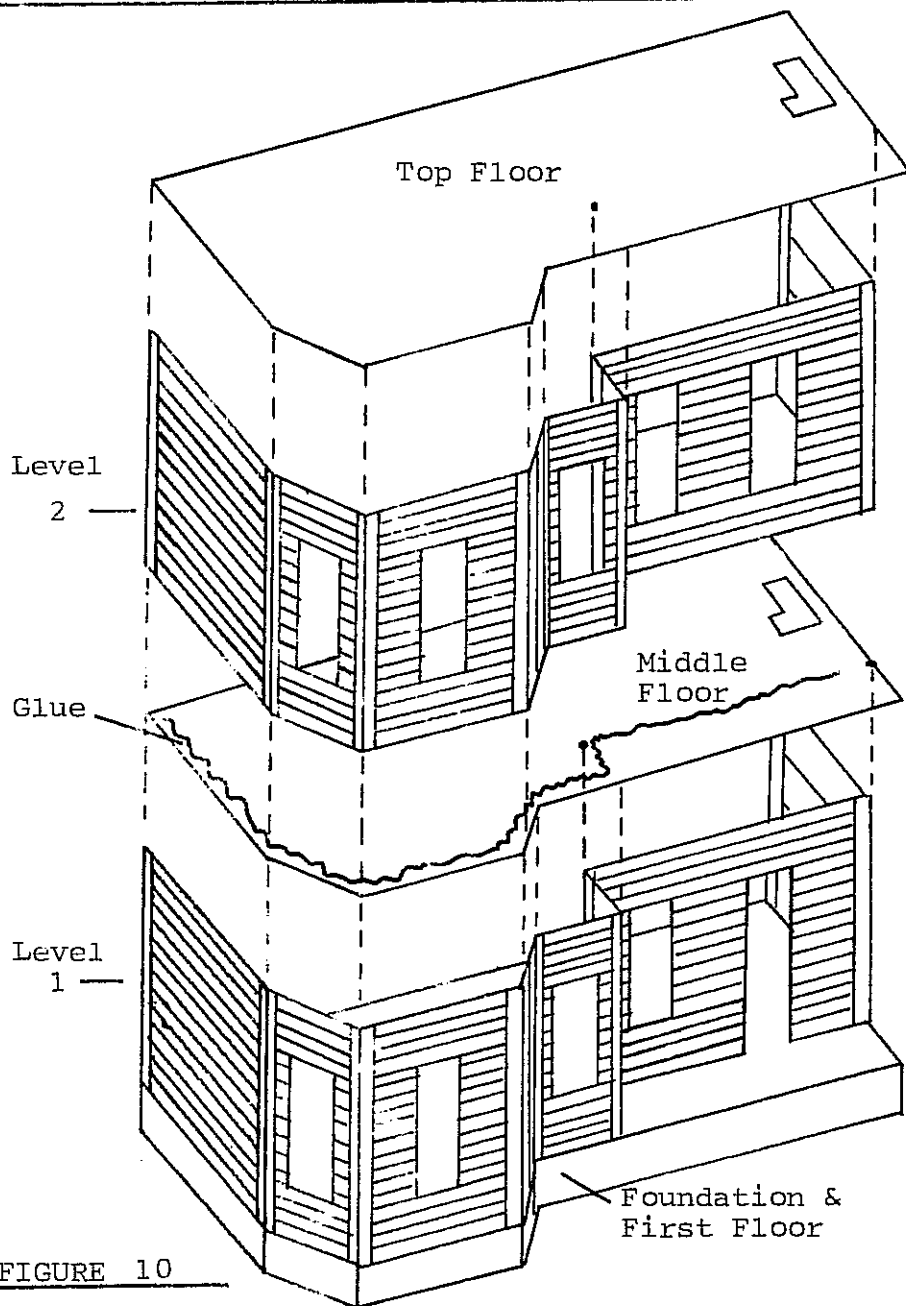

FIGURE 10

With a pencil, trace the outline of the walls of the base.

Next, remove the wall structure and apply white glue liberally to the base within the pencil outline.

Re-assemble the wall structure onto the floor over the glue track and then place the plywood middle or top floor on top of the walls.

Place books or other weights on the floor and allow the glue at the base to dry.

- 16) After the first level has dried the second level can be installed.

Apply a bead of glue all along the top of the clapboard wall sections of level 1.

Place a plywood floor (good side up) over the first level wall sections.

If desired, the installation of this floor can be further secured by nailing the floor to the level 1 corner connectors.

- 17) Install the level 2 clapboard siding sections repeating the procedure for level 1 outlined in section 15.
- 18) Repeat the procedure of step 16 for the top floor.

- 19) Assemble the tower room using the procedures outlined in previous sections.

Refer to Figure 12 and assemble tower wall section 3-B, and plywood sides.

Glue the corner connectors into position and interlock the wall sections together.

Assemble the completed tower wall sections to the top floor and glue into position as in step 15.

- 20) The dormer sides should be assembled to the front roof sections prior to roof assembly to facilitate installation.

- 21) Refer to Figure 11.

Select the front roof sections from your kit using Figure 1 as a guide.

Glue the dormer units to the roof as shown in Figure 11.

assembly.

First glue the triangular supports to the top of the dormer windows.

Next, glue the dormer sides to the front roofs as shown in Figure

After the dormer sides have dried, glue the window into position as shown in Figure 11. Then, simultaneously, glue the dormer roofs into position. Be sure to position the roofs in place as per Figure 11.

Tape the dormer roofs into position and allow the glue to dry.

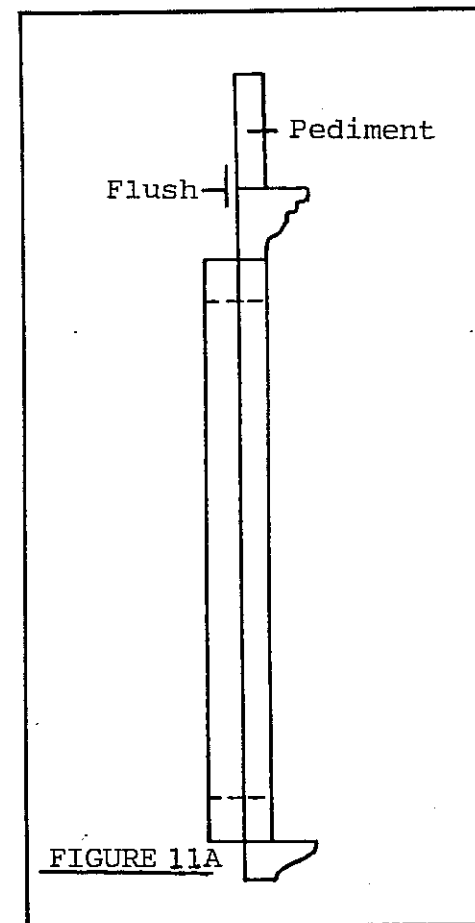
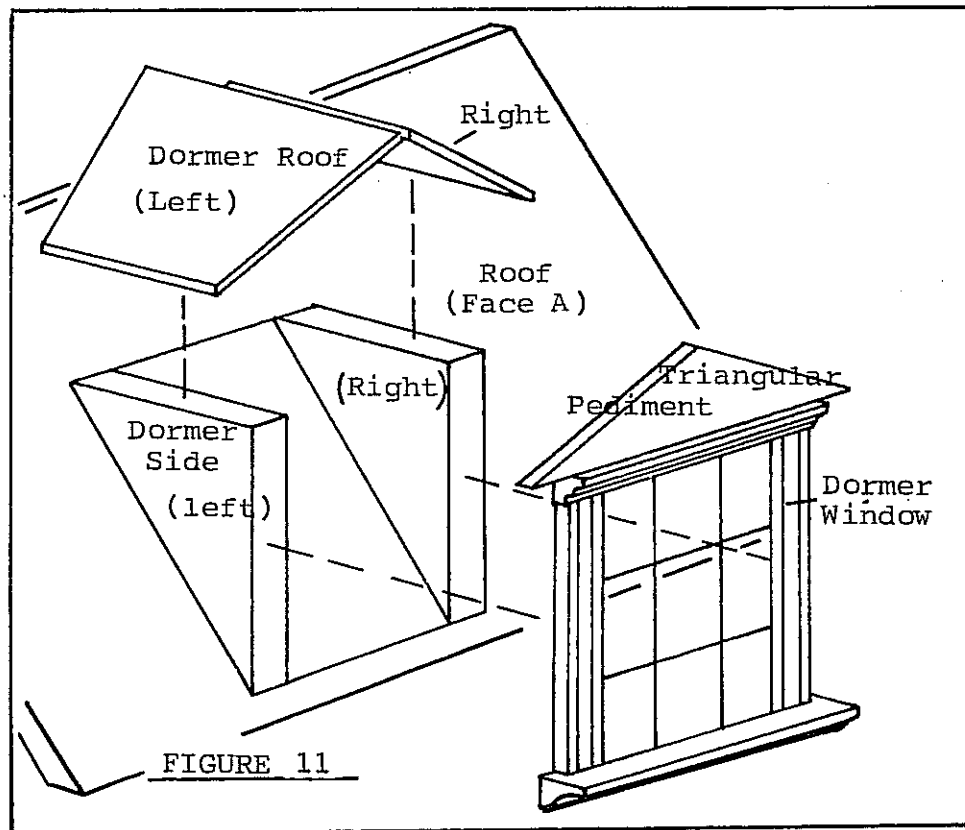

- 23) You are now ready to assemble the roof to the dollhouse.

Identify the proper orientation of the beveled edges as shown in Figure 12.

- 24) Starting first, with the left front roof, apply 1 or 2 strips of masking tape near the edge of the roof, allow about 3 - 4 inches of the tape to overhang the left edge flap-like.

- 25) Apply a bead of glue to the right and left edges and also to the bottom edge of the front roof.

- 26) Next, apply a bead of glue to the bottom and right edge of the left roof peak.

- 27) Position these 2 roof sections as shown in Figure 12 and tape together into position using the flaps from the front roof.

NOTE: Be sure to apply the glue generously and at this point do not be too particular about true positioning. Just be sure the roof-sections stand up in their approximate final position.

- 28) Repeat the above procedure for the right roof sections.

- 29) Apply a generous bead of glue to the top of the roof sections just installed and place the top roof into position as shown in Figure 12.

- 30) Tape the top roofs into place and now adjust all the roof sections into their final positions.

Apply additional holding tape as needed.

Be sure and wipe off all excess glue before it sets-up.

- 31) The top roofs should be lightly weighted down to assure good adhesion.

ROOF & TOWER ASSEMBLY

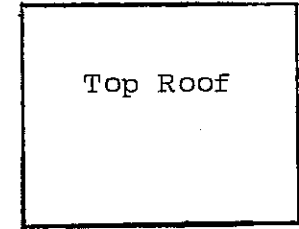
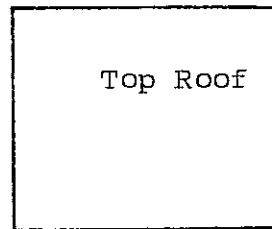
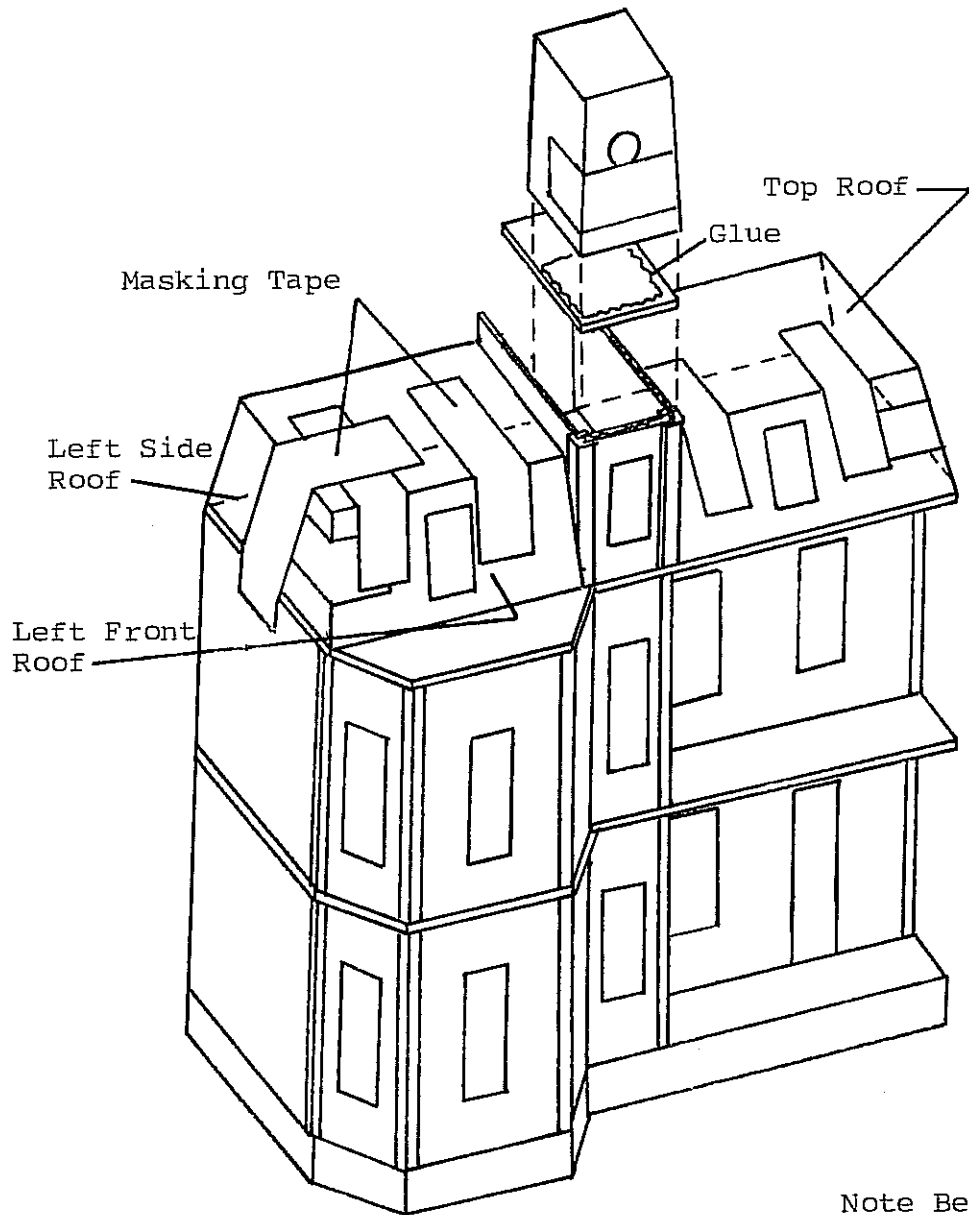

Tower - Level 3

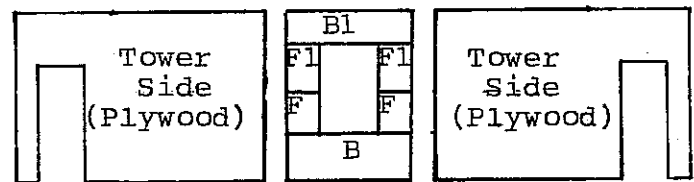

Section..A.....B.....C

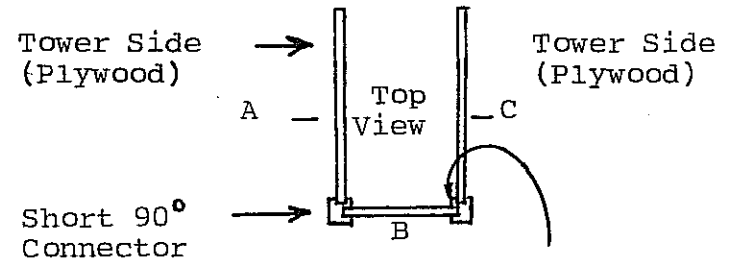

Leave 1/16" space on the inside of tower and fill in with wood putty or other suitable material.

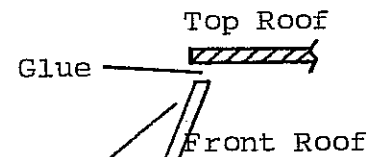

Note Bevels

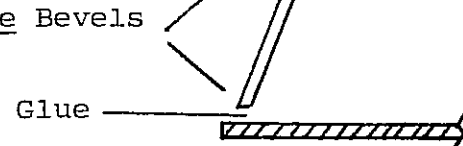

FIGURE: 12

32) Using the same procedures glue the tower roof into place.

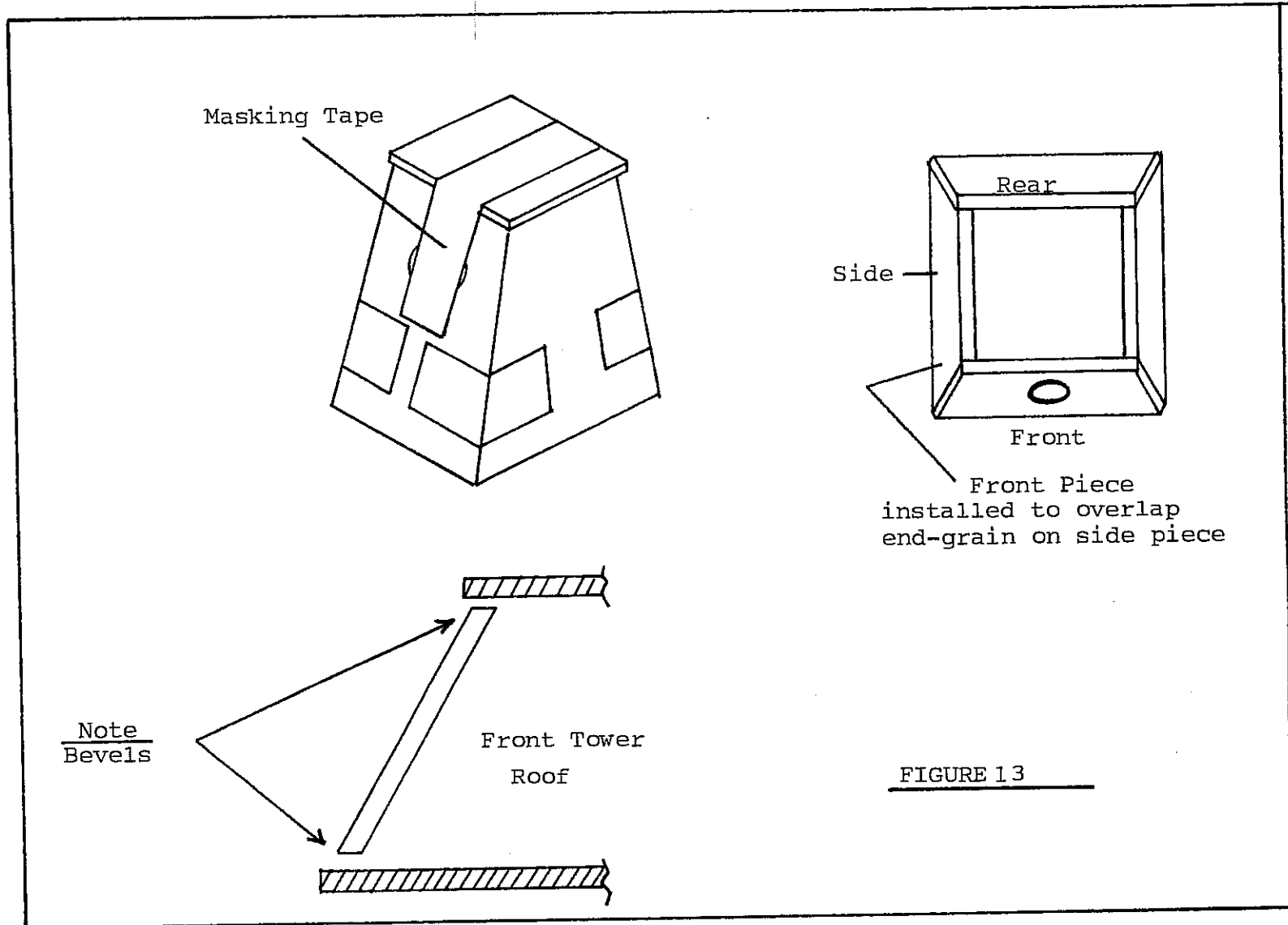

FIGURE 13

33) The basic structure is now complete and all that remains is to add the decorative trim, window, doors, stairs, and room dividers.

34) The porch railings should now be made up using the illustrations in Figures 14 and 15 as guides.

Use Figure 14 to identify the length of railing to use and the number of 1/8" dowels or posts to install.

DECORATIVE TRIM ASSEMBLY INSTRUCTIONS

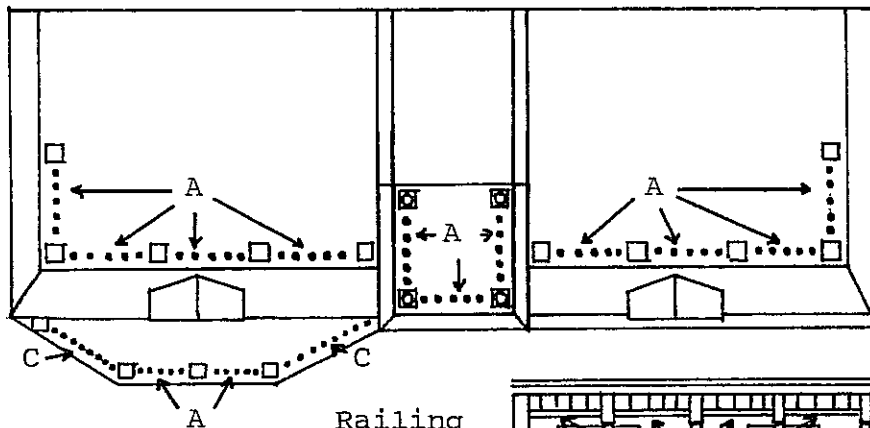

Section	Qty.	Dowel **	Railing Length
A	13	5	2-7/8"
B	11	4	2-19/32"
C	2*	8	4-7/16"
D	2	11	5-9/16"

*45degree angle both ends

**Dowels per section

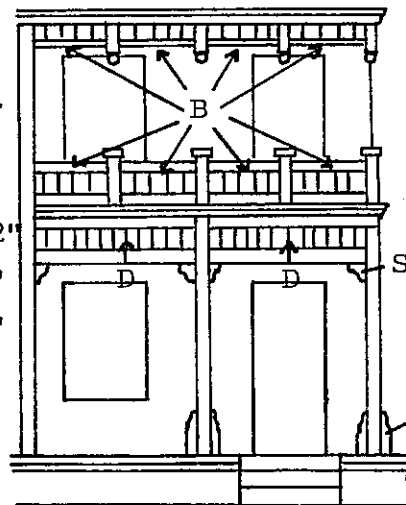

Right Side of Front

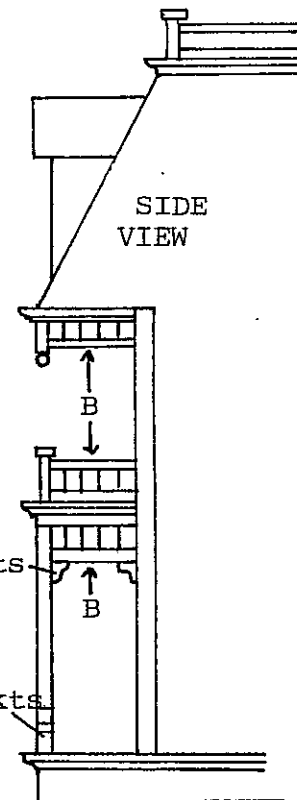

SIDE VIEW

Small Bkts

Large Bkts

Right Side

FIGURE 14

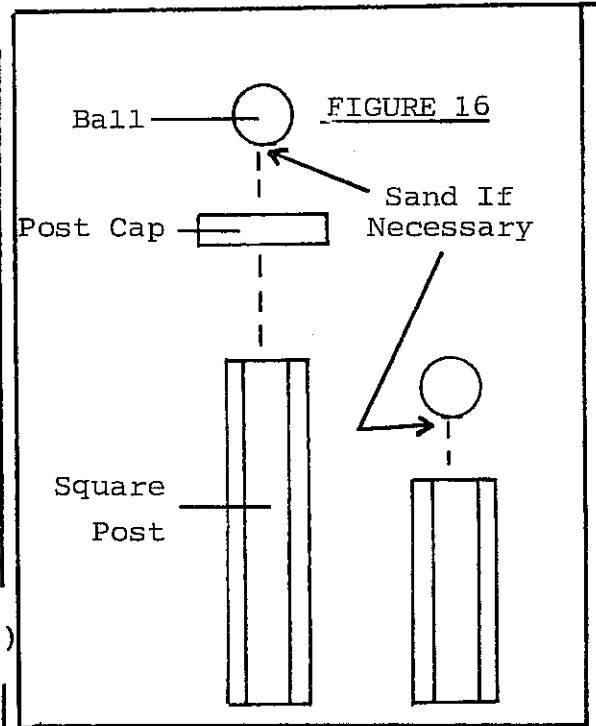
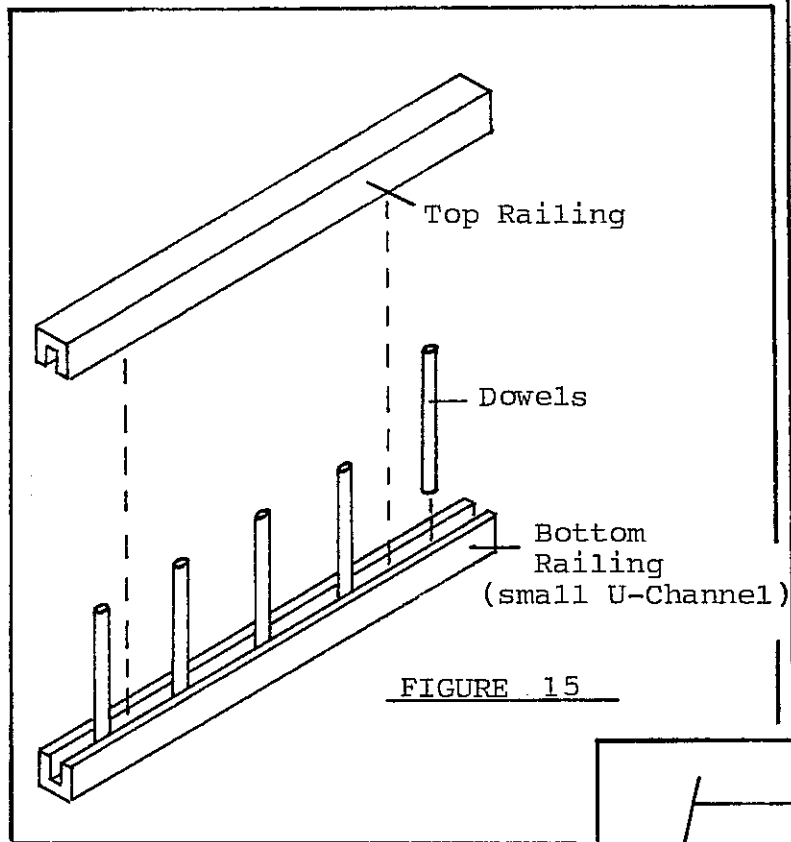

- 35) Apply a dab of glue to the bottom of each dowel and install as shown in Figure 15. Use approximately 1/2 inch spacing between dowels and keep the spacing uniform.

Be sure all the dowels are perfectly upright and perpendicular.

Install the top railing only after the dowels have dried.

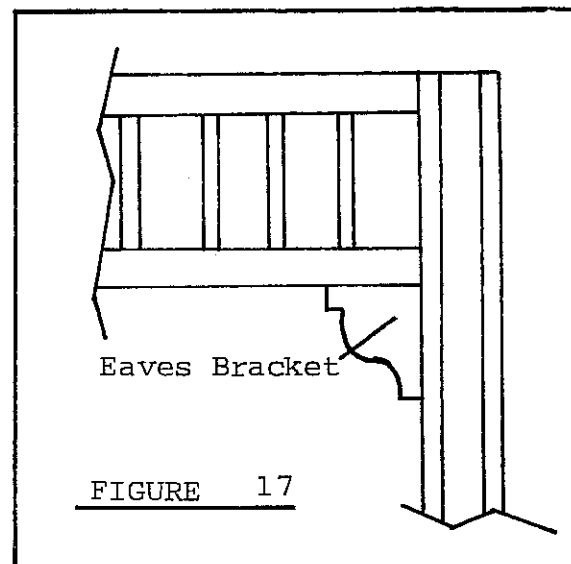

- 36) After all the railing sets have been completed install them into position on the dollhouse.

Use Figure 14 for correct orientation.

The square end posts are installed by merely applying a dab of glue to the bottom of each post.

- 37) Glue the large square porch posts into position as shown in Figure 16.

- 38) Install the eaves brackets as shown in Figures 14 and 17.

NOTE: Also refer to the photographs on the first page to aid in locating the proper positioning for all the trim.

- 39) The wooden balls are glued to the top of the short porch posts as shown in Figure 16.

Sand a small portion of the ball if necessary.

- 40) The large porch support brackets are glued into position as shown in Figure 14.

- 41) Next, install the edge nosing as shown in Figures 18 and 19.

The edge nosing is designed to cover the end grain of the plywood floors and to overhang down below the floor. This will cover up any space between the floor and the clapboard siding.

The edge nosing should be glued into position so that the top of the nosing is flush with the floor as shown in Figure 18.

Use Figure 19 to properly position each piece of molding.

NOTE: Always start gluing at the bottom edge of the dollhouse and work your way across the front to the other end of the house.

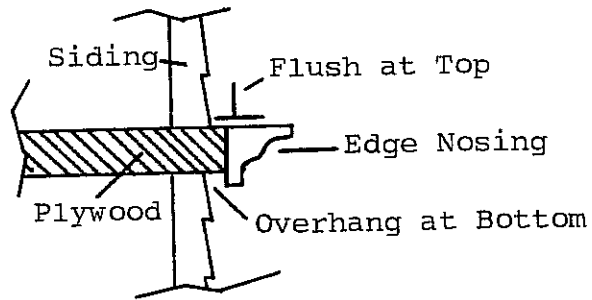
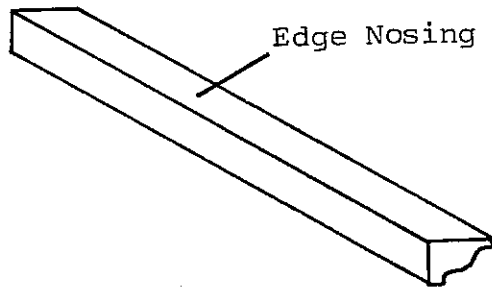

FIGURE 18

A/E

A1.....	7-7/16" long
A2.....	7" long
A3.....	4-1/2" long
E.....	4-7/8" long

B

B1.....	16-5/8" long
B2.....	17" long
B3.....	4-11/16" long

C

C1.....	16-5/8" long
C2.....	17" long
C3.....	4-11/16" long

D

	4-3/4"
--	--------

F

	18-1/8"
--	---------

EDGE NOSING
INSTALLATION

Note: A2,3
B2,3
C2,3
Nosing de-
signed to
cover $\frac{1}{4}$ "
plywood
end grain

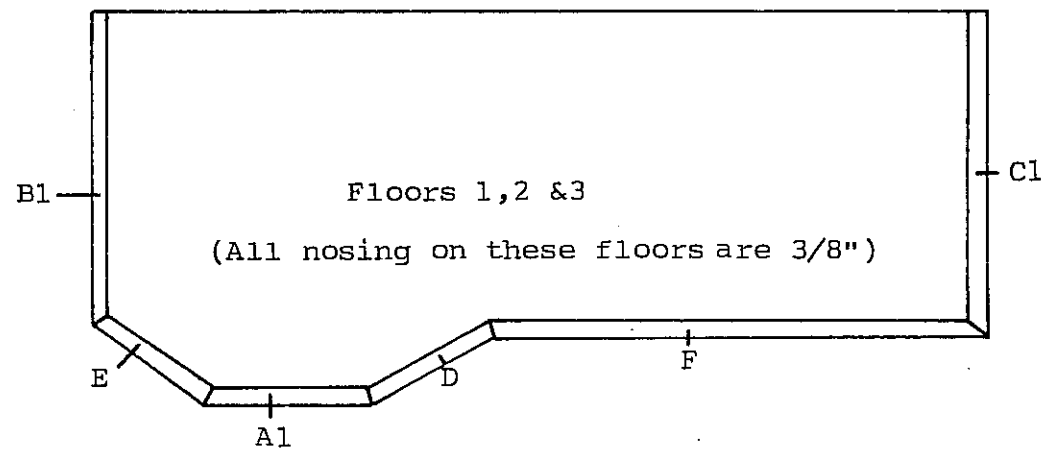
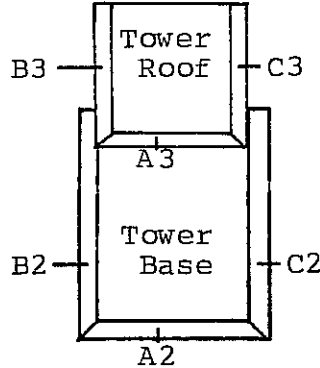
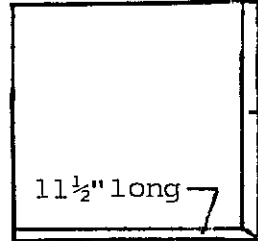
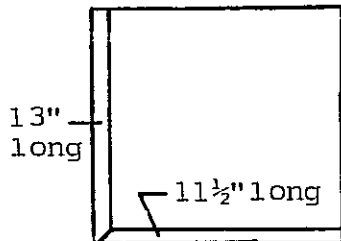

FIGURE 19



13" long
(Top roof
nosing is also
 $\frac{1}{4}$ " thick)

NOTES:

- 42) The circular window and plexi-glass are merely glued into place.
- 43) Assemble the 12 large windows using the special window assembly instructions on page 27, 28,29.
- 44) The windows are not usually glued into final position until the painting has been completed.

The tongues at the bottom of the window openings have to be sanded or filed down in order for the window to fit prpoerly.

- 45) Assemble the door using the special door assembly instruction section on page 30 and 31.
- 46) The partitions can be installed into the house and glued into place if desired. Weight down if necessary.
- 47) Figure 20 illustrates suggested room layout, however room partitions may be positioned accordingly to your preferences.

- 48) The false bottom assembly is described in Figure 23.
- 49) Use Figures 21 and 22 on pages 32 and 33 as guides for installing the interior and exterior staircases.
- 50) The set-up is now complete and the dollhouse is ready for decorating.

About Batrie Dollhouses

Batrie Dollhouses is one of the nations largest manufacturers of scale-model dollhouses.

From Federalist to Victorian, we offer a wide selection of additional styles and sizes.

In addition to our complete line of dollhouses, we also offer an extensive selection of windows, doors, architectural moldings, and room display boxes.

See your local dealer (or send for the name of your nearest dealer) for information on these additional Batrie Dollhouse miniature items.

BATRIE DOLLHOUSES
P.O. Box A
970 Fellsway
Medford, MA. 02155

Attn/ Customer Service

Suggested Room Layout

Back View

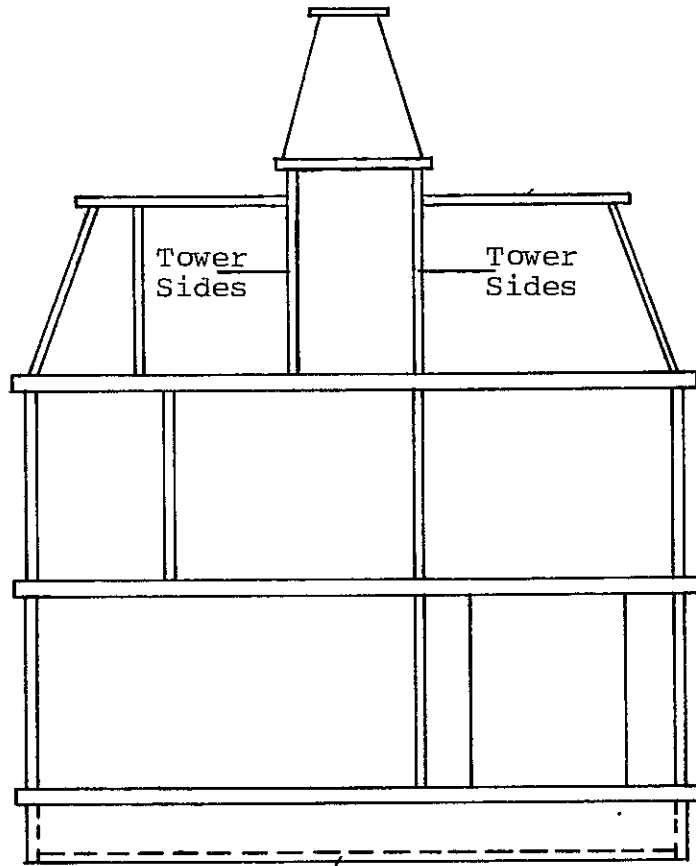

False Bottom

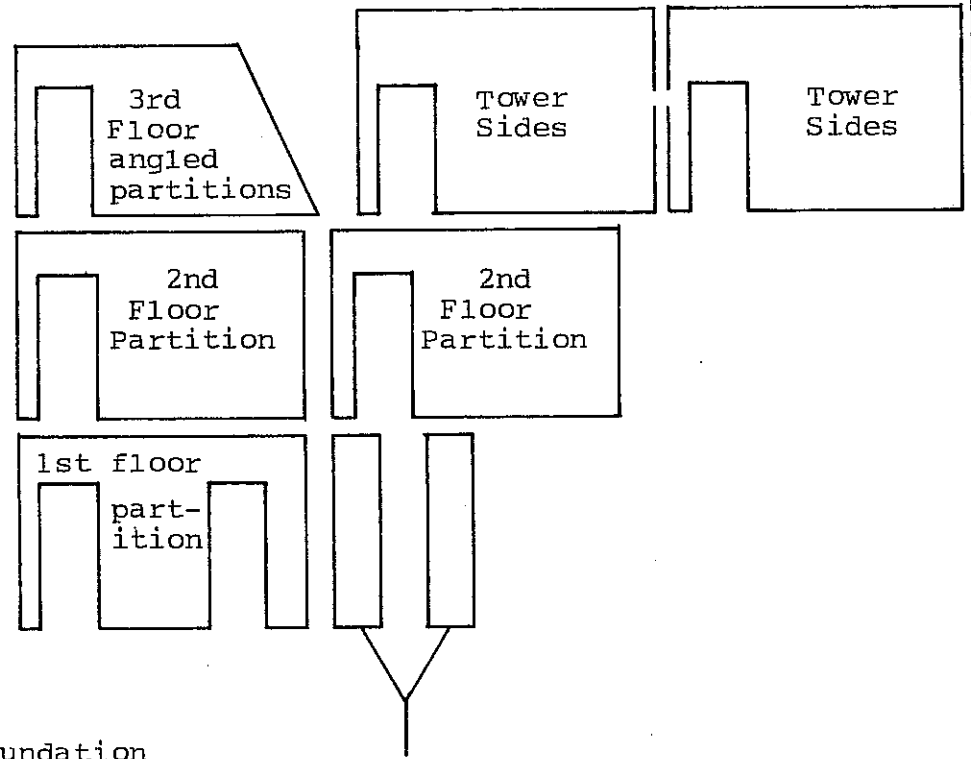

Foundation

Room Dividers

FIGURE 20

STANDARD WINDOW ASSEMBLY

The standard Batrie window kit and the smaller dormer window kit are assembled according to the following procedure:

- a) Identify and arrange the parts in the kit using the assembly diagram as an aid. Be sure of parts orientation before gluing.
- b) Put a dab of glue on both sides of the header and sill.

Refer to the Assembly Diagram.
- c) The plastic window is inserted into the grooves on the vertical stiles, header, and sill and pushed into position as shown in the Assembly Diagram.
- d) Slide the window over the edge of the table and wrap one end with an elastic band. As shown in the Assembly Diagram.

Carefully turn the window around and wrap an elastic band around the other end.

Check to see that the window is square at the corners; and the header and sill flush at the top and bottom.

- e) Let the glue dry and then assemble the decorative pediment and stool cap, if required, as shown in the Assembly Diagram.

NOTE: These parts are not glued flush to the rear of the window frame and should be installed as shown in the Assembly Diagram.

- f) Tape the pediment and stool cap, if required, into position with an equal overhang at each side of the window frame.
- g) Allow the window unit to dry thoroughly before using.
- h) If too tight during assembly sand or file the corners to fit.

WINDOW ASSEMBLY DIAGRAM

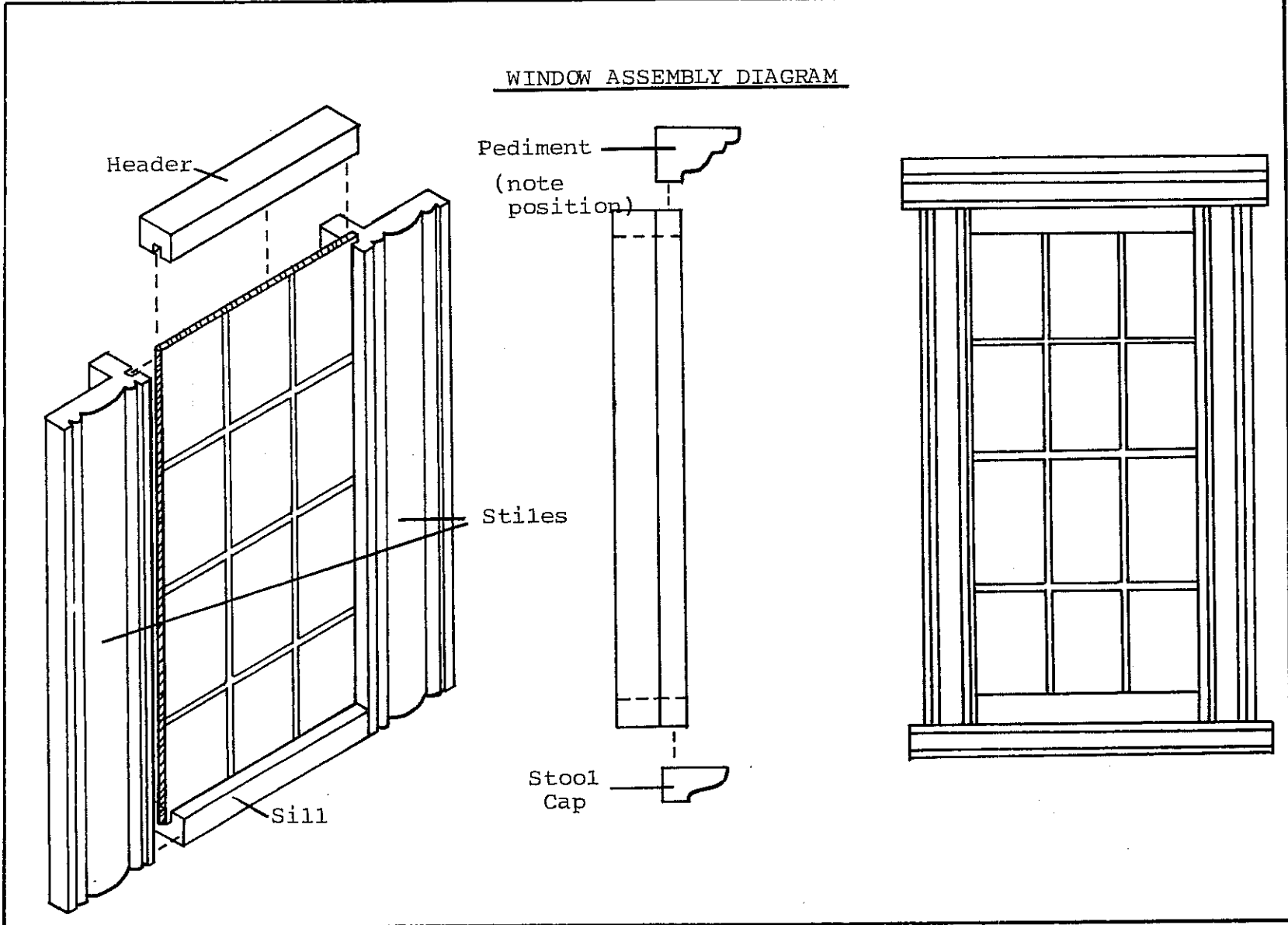

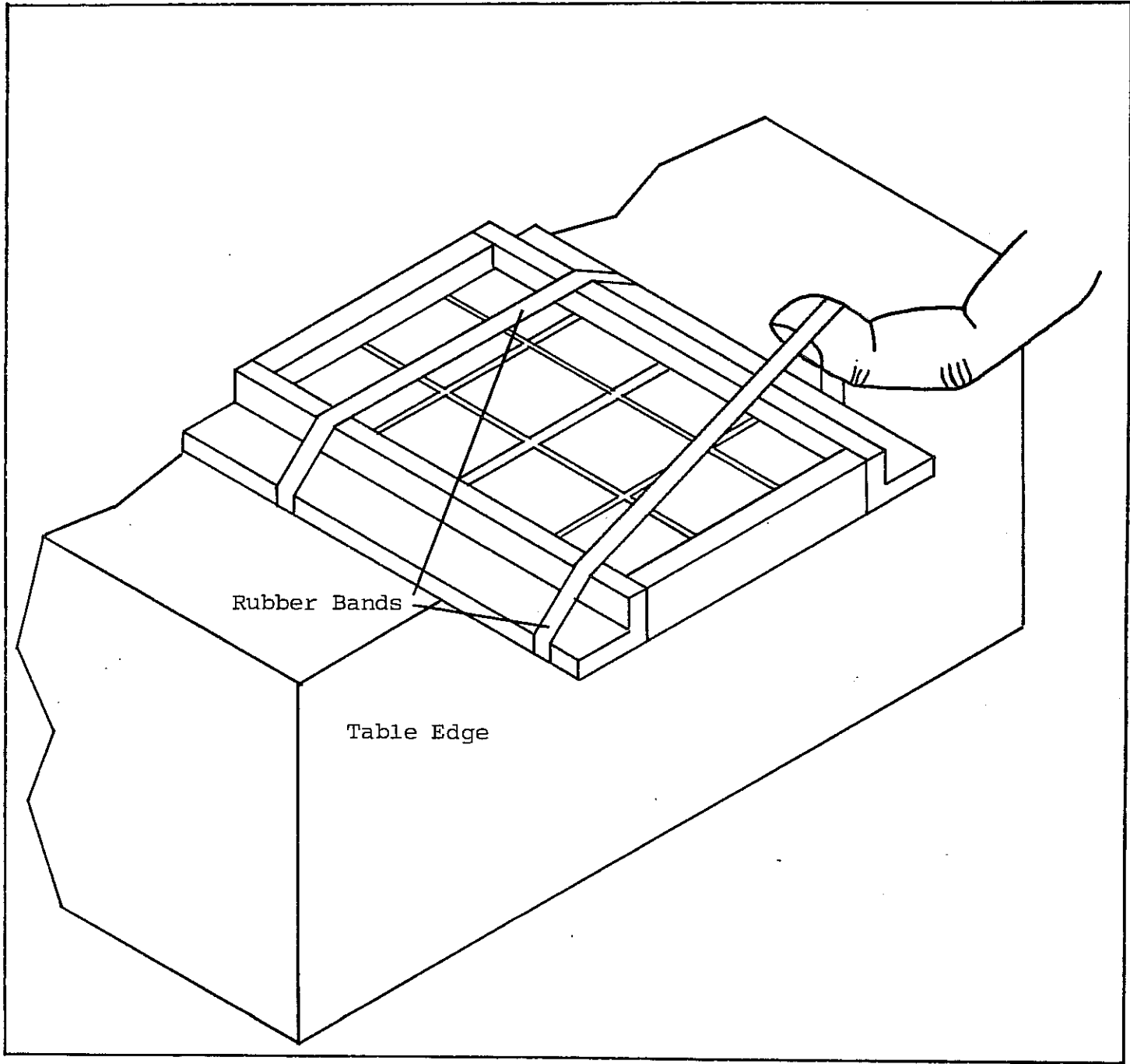

FRONT DOOR ASSEMBLY

Assembly instructions for the standard Batrie door.

a) Refer to the Assembly Diagram and identify and arrange the door parts.

b) Apply glue to each end of both the header and threshold.

Check parts orientation before gluing.

NOTE: The pre-drilled hole in the header and threshold should be at the right side.

c) Assemble the parts as shown in the Diagram and wrap securely with elastic bands around each end of the frame.

Check to see that the door frame is secure and the header and threshold flush with the sides of the frame.

d) After the glue has dried, install the door.

The door has a beveled edge, the beveled edge is the "hinge" on right side and permits easy opening and closing.

e) Using the nails provided in the hardware kit push the shorter nail through the hole in the threshold and into the door.

The longer nail goes through the header.

NOTE: Be sure to center the nails to avoid splitting the door.

f) Finally, glue the decorative door pediment, if required, into place as shown in the Assembly Diagram.

g) If too tight during assembly, sand or file the corners to fit.

DOOR ASSEMBLY

DIAGRAM

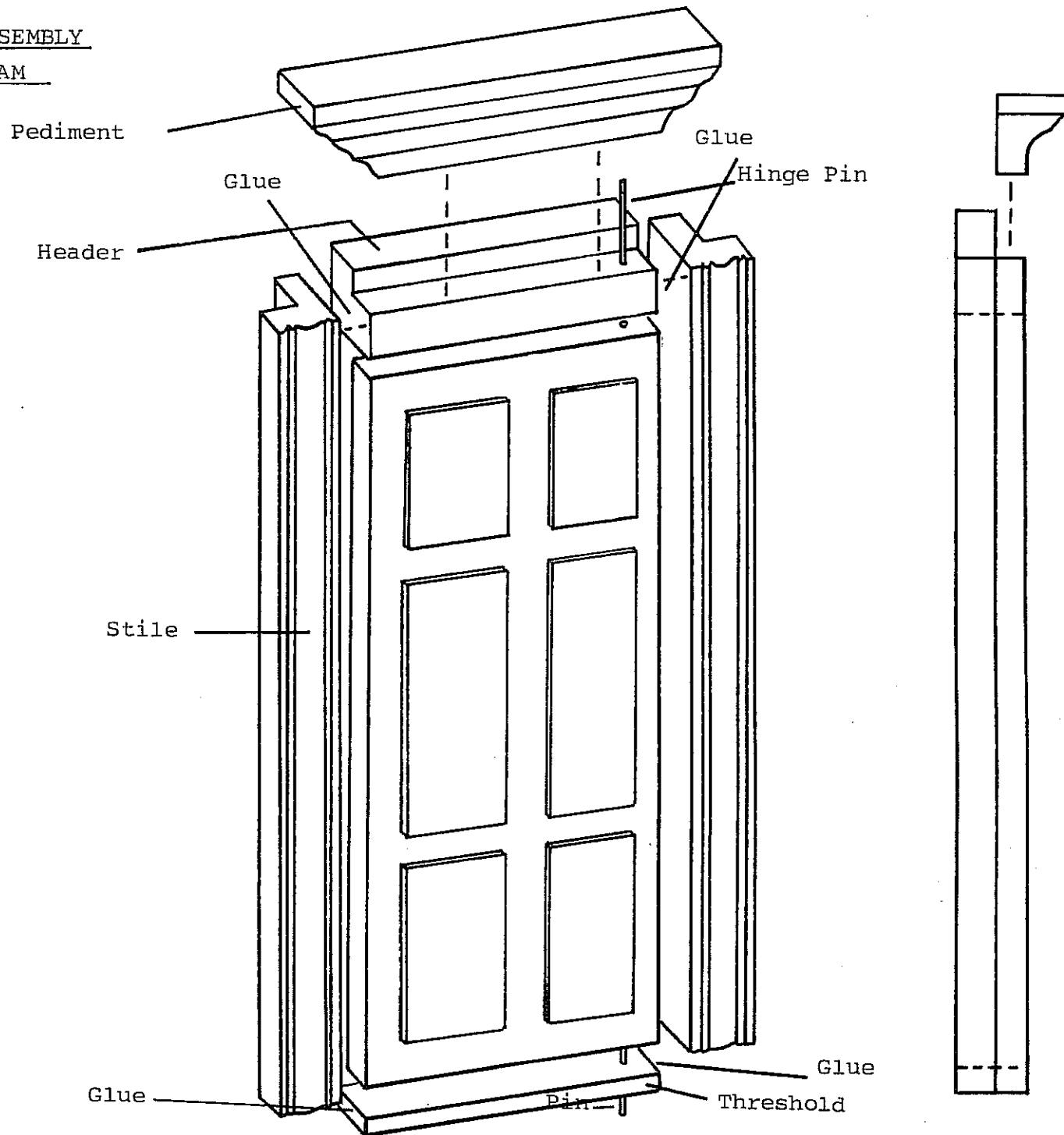

DIE-CUT INTERIOR STAIRS

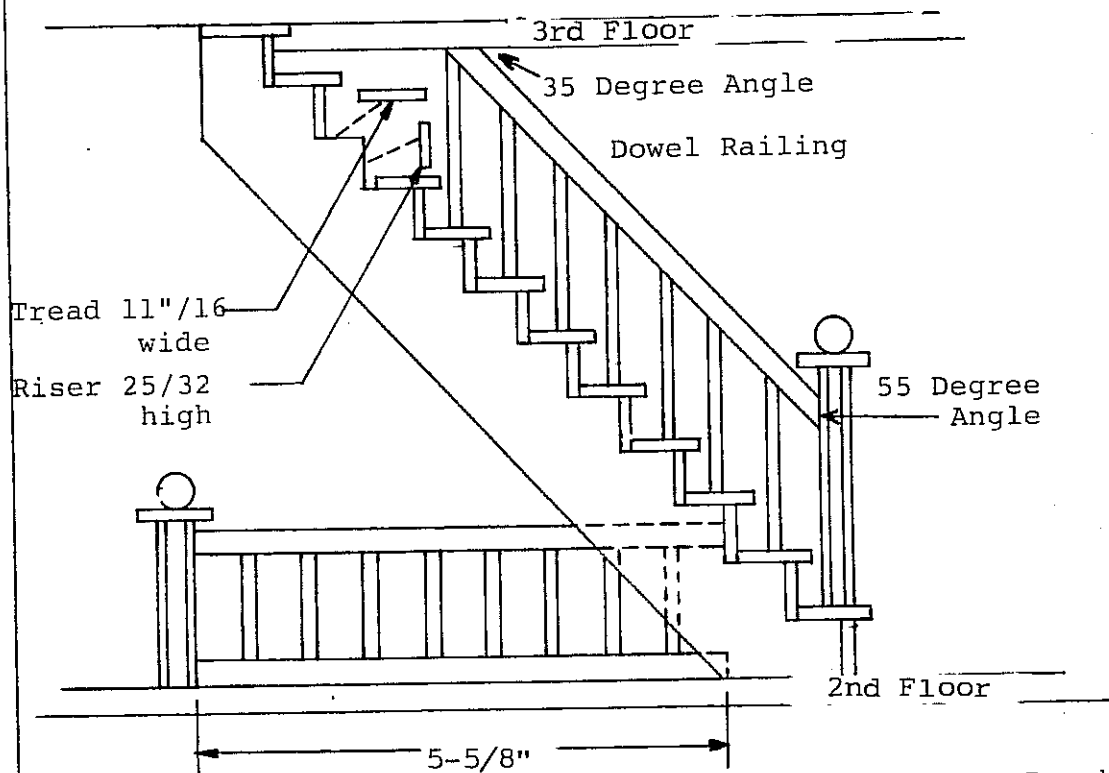

Punch out all pieces carefully from front to back. (where the cut marks are clearly visible) Due to the nature of die-cutting occasional sanding, filing, or cutting may be necessary to insure perfect fit. (Extra parts are provided)

FIGURE 21

DIE-CUT EXTERIOR STAIRS

TOP VIEW

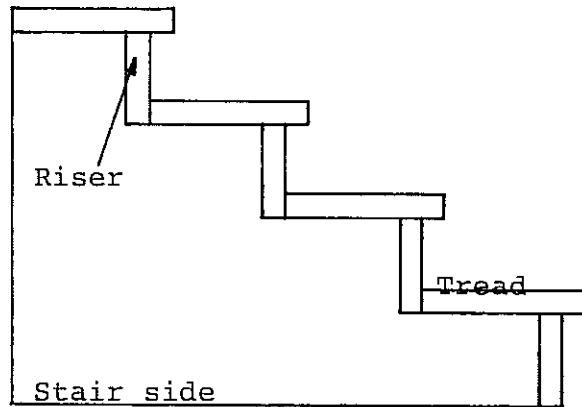

SIDE VIEW

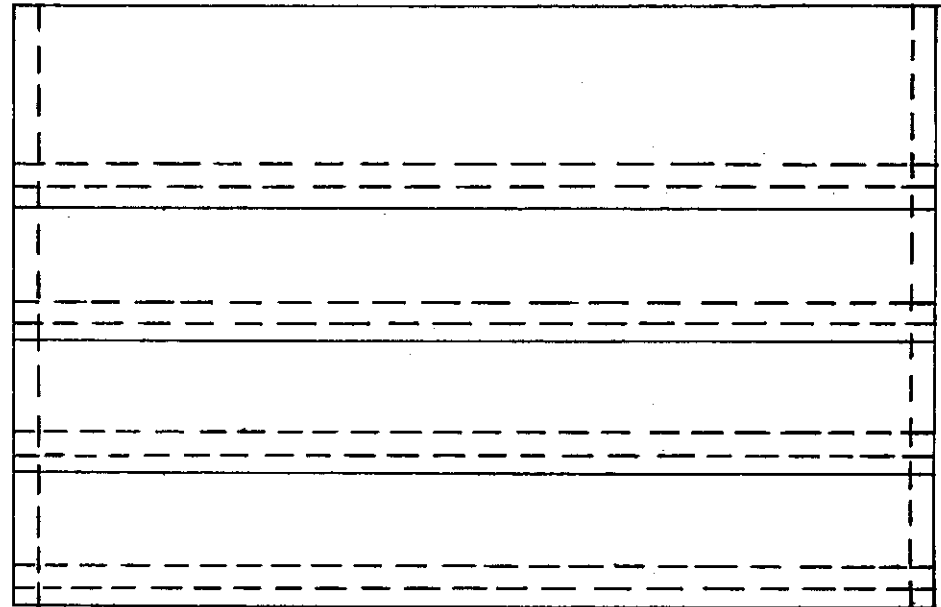

Punch out all pieces carefully from front to back. (Where the cut marks are clearly visible) Due to the nature of die cutting occasional sanding, filing, or cutting may be necessary to insure perfect fit. (Extra parts are provided)

FIGURE 22

FALSE BOTTOM ASSEMBLY

The False bottom allows for easy turntable (T-10C) mounting and also provides an excellent hidden space for electrical wiring.

TOP VIEW (Floor upside-down)

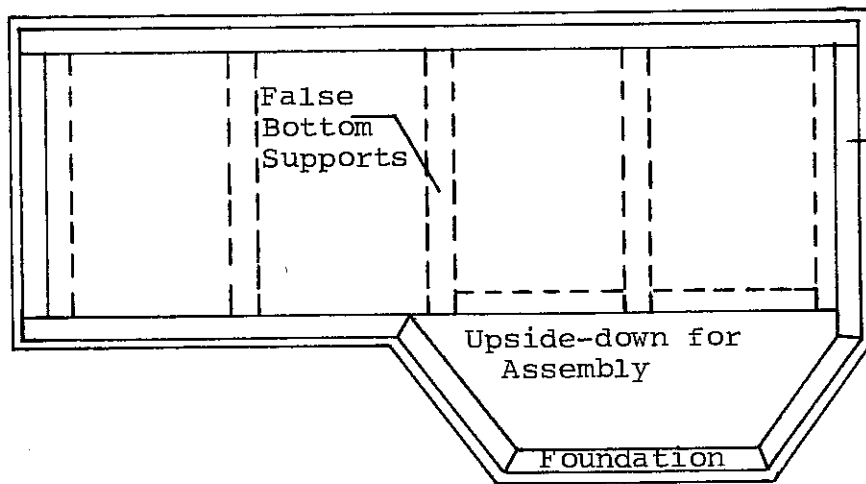

Foundation

SIDE VIEW (From right side)

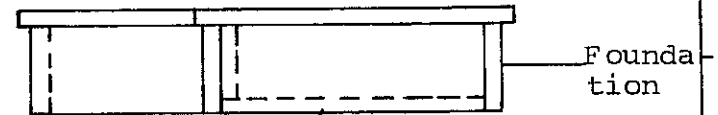

FIGURE 23