

Congratulations on your choice of a Real Good Toys product. Your kit has been precision made with meticulous care by our craftspeople using carefully selected materials. This Dollhouse will last for years, even generations, if heirloom care and attention is given during assembly. Take your time and read the instructions completely. If you have questions, ask the experts at your local Dollhouse store or at info@realgoodtoys.com

Before you begin - You have already opened the box and see all the parts organized in boxes and bundles. For the moment, keep them that way. There are important things to do before you open your glue bottle.

Choose your color scheme. Look at houses in your community, models in your local Dollhouse shop or at our website: realgoodtoys.com; look at plan books from a paint store or architectural books at your library (a favorite is: *Painted Ladies* by Michael Larsen and Elizabeth Pomada). You will be painting some of the parts right away so get the paint now. Choose high-quality semi-gloss latex enamel paints for ease of use and durability.

Prepare your space: This dollhouse will spread out over a large area while it is being built. You will need a large flat tabletop for the house, several boxes to keep parts organized until they are needed, and several trays lined with waxed paper for holding small parts like windows and railings. A snap-lid box will keep your tools and supplies handy between building sessions.

Measure and identify the parts: The kit is packed in groupings that protect the parts, and that is how the Parts List is organized. As you measure and identify the parts, label them with sticky notes using the names from the parts list, and check them off the parts list so you know you have everything. Taking the time now to identify and organize the parts also makes them familiar so you will understand what the instructions intend as you read ahead.

- Plan ahead so you know where you are going
- Read ahead so you know how to get there
- Paint ahead so the parts are ready when you need them

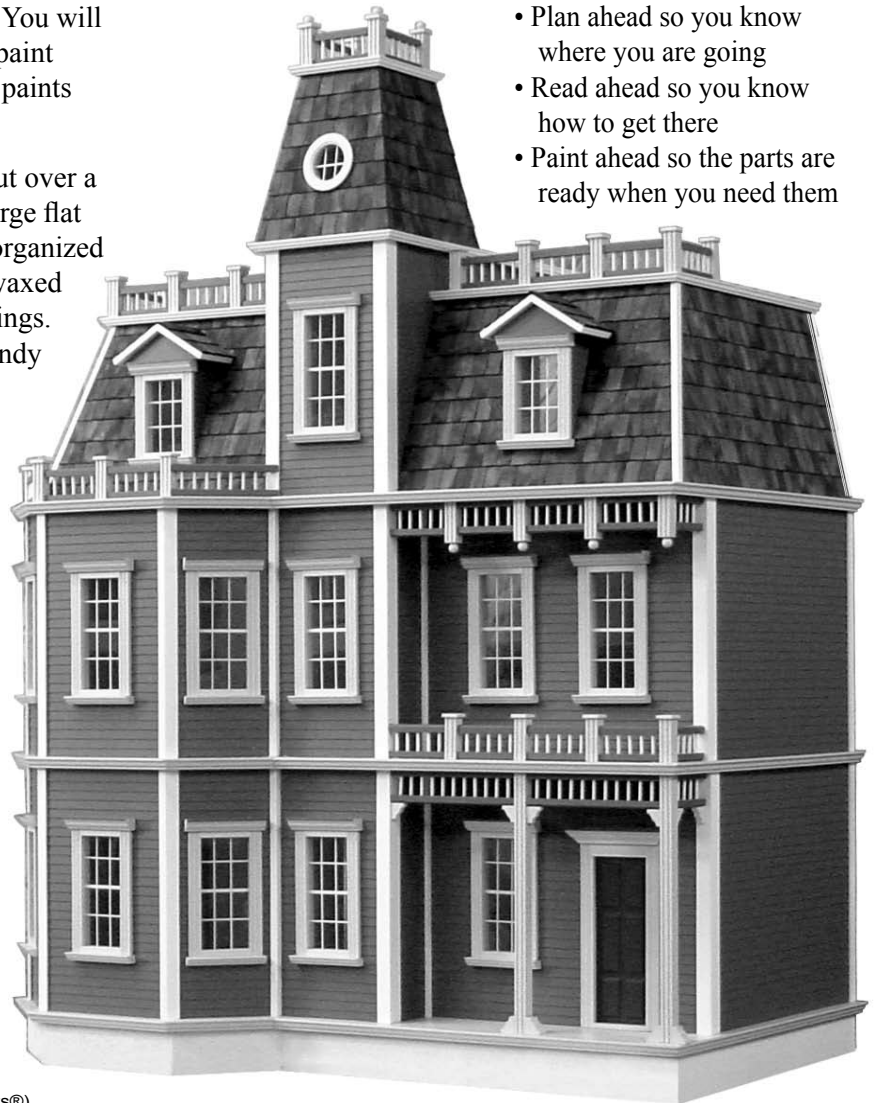

Tools and Supplies:

Tape measure or ruler, Pencil, Sticky notes (like Postlts®)
White glue (like Aleene's Tacky Glue®) for all construction
Solvent-based Panel Cement for shingles
Masking tape, Utility knife or coarse file, yardstick
Fine tooth saw (razor saw (like X-Acto®) or a hacksaw)
Painting Supplies, Sandpaper (especially 320gr)
Waxed paper, Rubber Bands #8 and #32

Postlts®, Aleene's®, and X-Acto® are registered trademarks of their manufacturers and have no affiliation with Real Good Toys

Not suitable for children under 13 years of age
California 93120 compliant for formaldehyde phase 2

Options: see your miniature dealer and www.realgoodtoys.com
EL-66 Hole starter and electrification tool
Stucco Grit: Paint additive for foundation texture
6007: 6-panel interior doors fit the Dividers
Dye-1: Brown shingle dye
Dye-3: Grey shingle dye
SC: Copper flashing



This kit will accommodate 1" Scale furniture

Identify the parts: Open one bundle at-a-time. Measure each part and find it on the parts list. Label the parts and group them by the 'instruction section #' at the end of each part's name(#). These groups are how the parts will be used.

"MP" kit builders: You must paint the walls now. Do not sand, fill, scrub, prep, or even stack and handle the walls unnecessarily before the first coat of paint fills the grain and reinforces the clapboard edges.

- (1) 7101 Base Floor¹ (1/4Ply) 20 x 31⁷/₈
- (2) 7121 Upper Floor² (3/8Ply) 20 x 31⁷/₈ with stair hole
- (2) 7102 Roof Top³ (1/4MDF) 11¹/₄ x 12¹¹/₁₆

(1) Panels Pack

- (1) 7103 Tower Floor³ (1/4MDF) 16⁵/₈ x 6¹/₂
- (1) 7104 Left Front Roof³ (1/4MDF) 12³/₄base x 8¹¹/₁₆tall, window
- (1) 7105 Right Front Roof³ (1/4MDF) 12³/₄base x 8¹¹/₁₆tall, window
- (1) 7106 Left Side Roof³ (1/4MDF) 15⁵/₁₆base x 8¹/₄tall, angled
- (1) 7107 Right Side Roof³ (1/4MDF) 15⁵/₁₆base x 8¹/₄tall, angled
- (1) 7122 1-Door Divider⁸ (3/8Ply) 10 x 13, doorway
- (1) 7123 2-Door Divider⁸ (3/8Ply) 10 x 15³/₄, doorway
- (3) 7124 1-Door Divider or Tower Sides⁸ (3/8Ply) 10 x 15³/₄
- (1) 7125 Attic Divider⁸ (3/8Ply) 15⁵/₁₆base x 8¹/₃₂tall, doorway
- (2) 7126 Blind Dividers⁸ (3/8Ply) 10 x 2¹/₂

(1) Walls Pack² (MP Milled Plywood, MM Milled MDF, or B Brick)

- (2) Section A: 10 x 15⁹/₁₆
- (4) Sections B or D: 10 x 4¹/₁₆, window
- (2) Section C: 10 x 6³/₁₆, window
- (3) Section E: 10 x 5 window
- (2) Section F: 10 x 2³/₁₆
- (1) First Floor G: 10 x 12¹/₂ with window and door
- (1) Second Floor G: 10 x 12¹/₂ with windows
- (2) Section H: 10 x 12¹/₂

(1) Foundation Pack¹

- (1) 7131 Front Foundation: 31⁹/₁₆ x 11⁵/₁₆, Beveled
- (1) 7132 Back Foundation: 31⁹/₁₆ x 11⁵/₁₆, Branded
- (4) 7133 Middle Foundation: 15⁵/₈ x 11⁵/₁₆
- (2) 7134 Bay Middle: 2³/₄ x 11⁵/₁₆
- (2) 7135 Bay Side: 4⁷/₁₆ x 11⁵/₁₆, 22¹/₂°\45°
- (1) 7136 Bay Front: 6⁷/₈ x 11⁵/₁₆, 22¹/₂°\22¹/₂°

(1) Tower Roof Pack³ (pack "71J")

- (3) E6519 Tower Roof
- (1) E6520 Tower Front Roof
- (1) E6521 Tower Roof Top 4¹/₂ x 4

950 Shingles⁶ "SWR" Style

(1) Front Step pack #D96A

- (1) 2nd Step (1¹/₁₆ Pine) 1 x 4⁵/₈
- (1) 1st Step (9⁹/₁₆ Pine) 2 x 4⁵/₈
- (2) Tread (1¹/₈) 1¹/₈ x 4⁷/₈

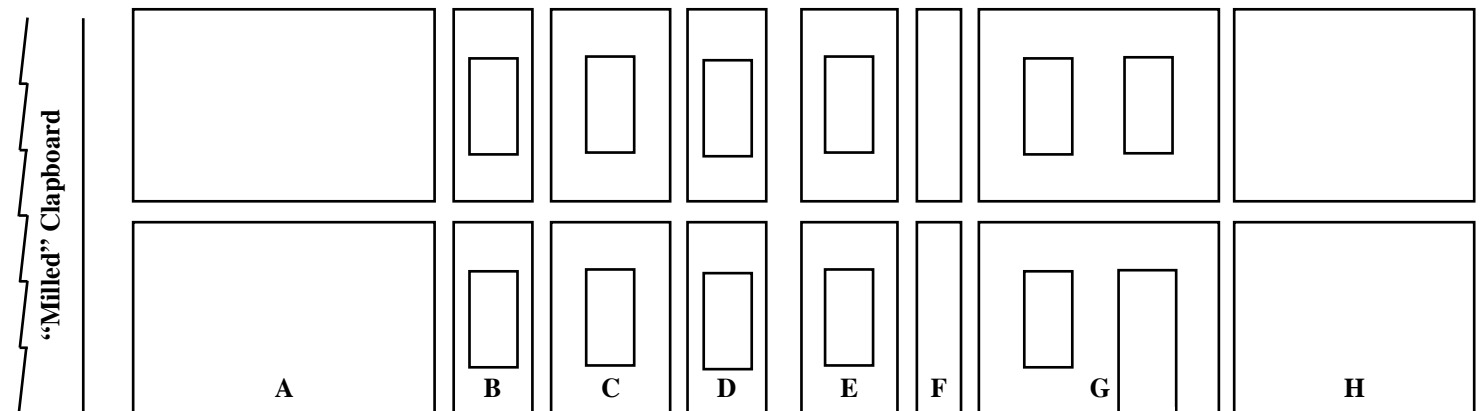
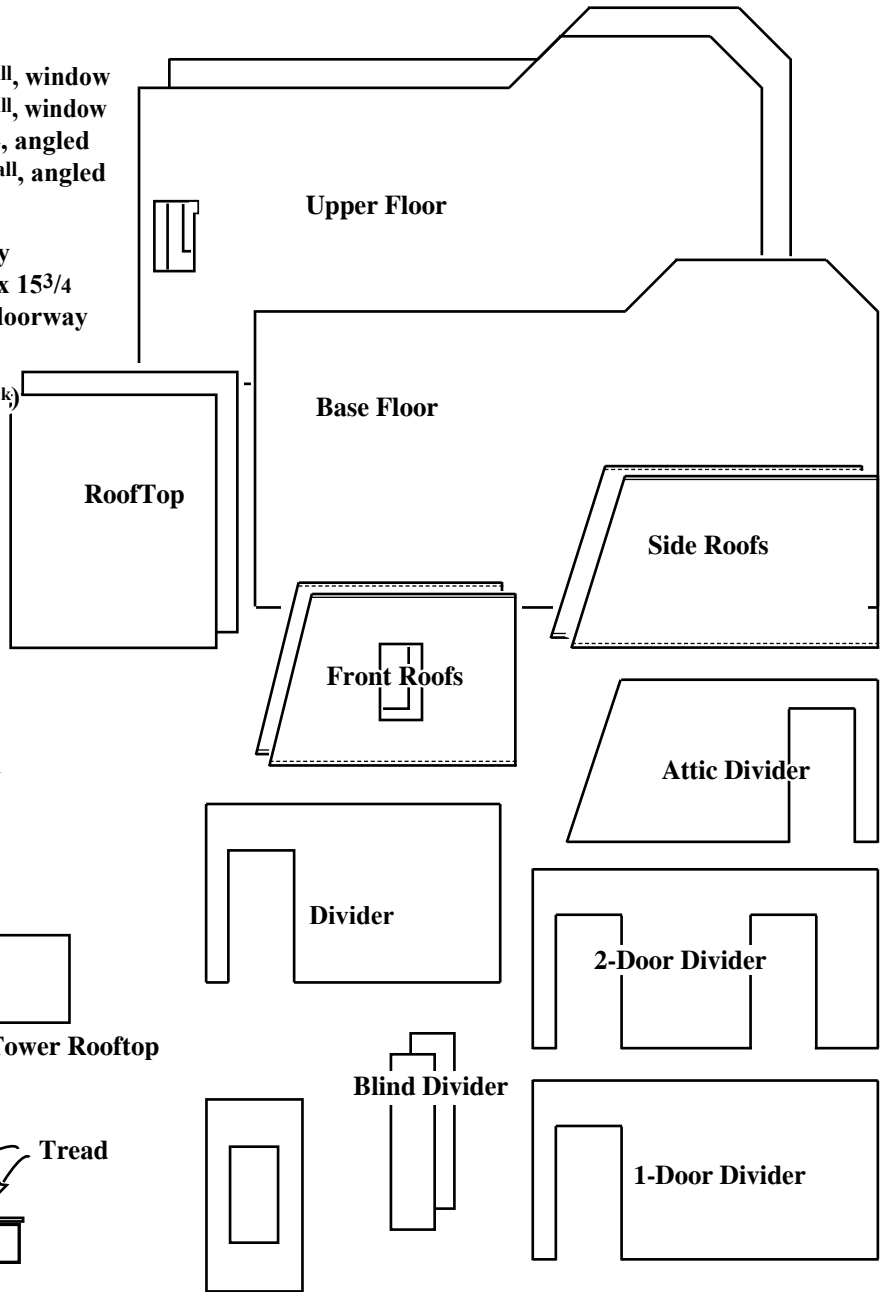

DH71K Components Box

- (12) W12A Assembled Standard Window Frames⁶
- (2) W22A Assembled Dormer Window Frames⁴
- (14) E6496 Window Pediment^{4&6} (1/2 x 5/8 molding): 31/4"
- (14) E6497 Window Stool Cap^{4&6} (5/16 x 9/16 molding): 31/4"
- (12) E6501 Standard Window Pane⁶ 21/8 x 45/8
- (2) E6502 Dormer Window Pane⁴ 21/8 x 31/8
- (1) D12A Assembled Door⁶

Dormer Pack⁴ (2 Sets):

- (4) E6503 Dormer Side 45/8 x 17/8 @ top
- (2) E6504 Triangle 41/4 x 11/4 tall
- (2) E6505 Left Roof 2¹³/16 x 2¹³/16, angled
- (2) E6506 Right Roof 2¹³/16 x 2¹³/16, angled

Trim Pack⁵:

- (26) E6513 Post (1/2 Flutepost) 15/8
- (22) E6514 Post Cap (1/8) 11/16 x 11/16
- (8) E9009 Wooden Balls 3/8
- (150) E6516 1/8 Dowel 1"
- (6) E6517 Bracket 1/4"
- (4) E6518 Corbel 1/2"
- (1) 5070 Round Window
- (1) 5070 Round Plexi

Rail Pack⁵:

- (4) E6476 5/8 Rail
- (4) E6475 47/16" Rail, mitered
- (26) E6477 2¹³/16 Rail
- (16) E6478 2¹¹/16 Rail
- (6) E6479 27/16 Rail

Stair Set⁷

- (2) E6524 Outside Stringer (1/8 x 3/4) 12¹/₂"
- (2) E6525 Inside Stringer (1/8 x 3/4) 12³/₁₆"
- (4) E6522 Stair Block (6 step molding) 27/8"
- (2) E6523 Top Block (1 step molding) 27/8"

Connectors² etc. (in separate bundles)

- (8) E6527 90° (5/8 x 3/4 grooved) 10
- (8) E6526 135° (3/4 x 3/4 grooved) 10
- (4) E6528 End Cap (1/2 x 9/16 grooved) 10
- (2) E6529 Porch Post (1/2 Flutepost) 10
- (6) E6530 Shingle Board Stock: (3/32 x 1/4) 10

Banister Pack⁷

- (2) E6471 Banister Handrail 87/8" beveled ends
- (20) E6474 1/8 Dowel 27/16"
- (5) E6533 1/8 Dowel 2" ○
- (2) 7012X Turnpost 31/2"
- (1) RGT4 Turnpost 27/8"
- (1) E6472 3" Top beveled Rail
- (1) E6473 45/16" Bottom beveled Rail

1/4" Nosing⁴: (the first measurement is the smooth gluing edge)

- (1) E6480"A" 12¹¹/₁₆ 90° \ 45° 12¹⁵/₁₆
- (1) E6481"B" 12¹¹/₁₆ 45° / 90° 12¹⁵/₁₆
- (1) E6482"C" 11¹/₄ 45° \ 90° 11¹/₂
- (1) E6483"D" 11¹/₄ 90° \ 45° 11¹/₂
- (1) E6484"E" 4¹/₂ 90° \ 45° 4³/₄
- (1) E6485"F" 4¹/₂ 45° \ 90° 4³/₄
- (1) E6486"G" 4 45° \ 45° 4¹/₂
- (1) E6487"H" 16⁵/₈ 90° \ 45° 16⁷/₈
- (1) E6488"I" 16⁵/₈ 45° / 90° 16⁷/₈
- (1) E6489"J" 6¹/₂ 45° \ 45° 7

3/8" Nosing⁴: (the first measurement is the smooth gluing edge)

- (3) E6490"K" 16⁵/₁₆ 90° \ 22¹/₂° 16¹/₂
- (3) E6491"L" 47/8 22¹/₂° \ 22¹/₂° 5¹/₄
- (3) E6492"M" 7 22¹/₂° \ 22¹/₂° 7⁵/₁₆
- (3) E6493"N" 4¹/₂ 22¹/₂° // 22¹/₂° 4¹¹/₁₆
- (3) E6494"O" 18³/₁₆ 22¹/₂° \ 45° 18⁵/₈
- (3) E6495"P" 16⁵/₈ 45° / 90° 17¹/₁₆

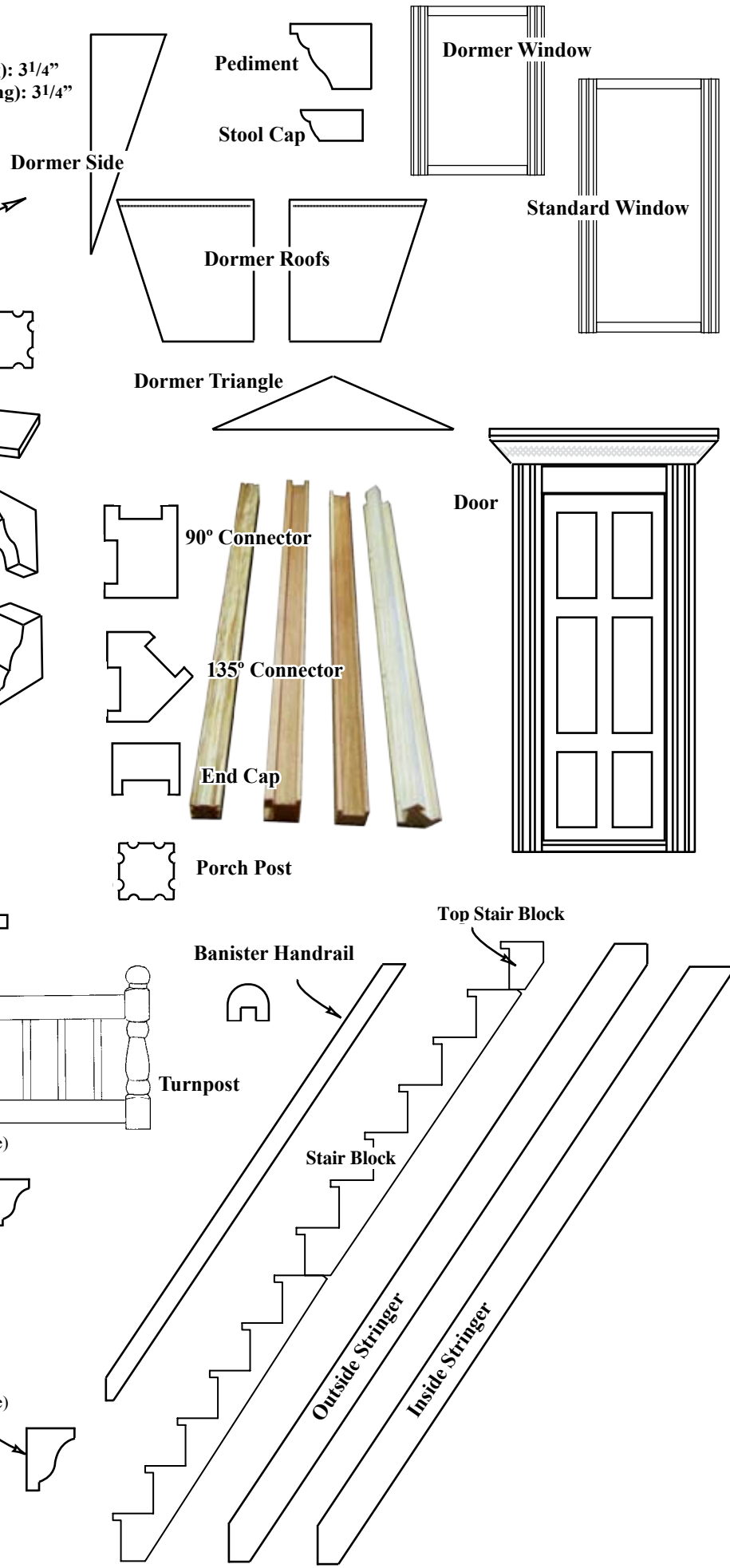

Assembly Notes:

A large, clutter-free, well-lighted work area is helpful during assembly, but a flat work surface is essential.

Read the instructions carefully; look at each of the illustrations. **!With the parts in your hands!**, think the assembly through before you proceed.

Test fit each time you are ready to glue a piece in place...then you'll know you have it right.

If more tape or a helper is needed, it's good to know that before the parts have glue on them.

Don't be stingy with glue or tape; use generous amounts. Always wipe off excess glue immediately.

Keep one damp rag and one dry rag handy all the time.

Have weights available for holding things tight as glue joints dry (stacks of books, gallons of pure Vermont Maple Syrup - anything heavy)

Glue the body of your dollhouse together with white, water clean-up glue that dries clear. Do not use instant-bond (super glue), fast-tack, rubber cement, silicone, or hot melt glues. They are all used in some wood applications, but they all have some characteristic that makes them un-desirable for the body of your dollhouse.

Carpenter Glue works well, but glue-smear dries yellow or tan; many of the things you glue onto the house are pre-painted – extra glue will show. I use Aleene's Tacky Glue® for all house body assembly.

Make sure everything is straight and flat as glue dries... That's the shape that will be permanent.

Glue the shingles on with glue that doesn't have any water in it! If the glue says "water clean-up", it will curl the wooden shingles. Look carefully at the glue you intend to use to be sure it is solvent-based, or use hot-melt glue (and watch out for the burns). I use Liquid Nails #LN-601® glue which comes in a caulking-gun tube at the hardware or building supply store (note – Liquid Nails® also makes #990 which is "water clean-up" and will curl the shingles). Check ingredients and warnings. Solvent-based glues say "Caution, Flammable" on the front.

If you Wallpaper, use "Border" paste (for wallpaper borders), "Grandma Stover's" (YES!), or Mucilage.

Brush paste on the wallpaper, then the wall, and finally smooth the wallpaper into position.

When glue is drying, skip ahead to up-coming assembly steps and prepare the parts that will be used.

OnLine Support: There are many photos of this house under construction as well as tips, techniques, and extra help with your dollhouse project at: www.dhbuilder.com

A: Getting Started: Do these things before the house assembly **Square the corners** of the window, door, and stair holes with a utility knife - each cutout has a rounded corner left over from the tool that made it. Make two cuts in each corner from the outside (one from each direction), then cut from each direction on the inside to cut away the rounding in the corner so the window, door, or stairs will fit.

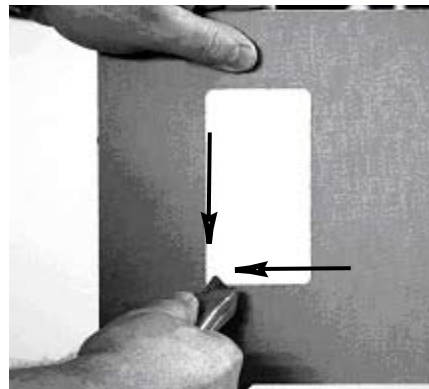

Stain the Shingles: Our pro uses Real Good Toys' Shingle Dye (available through your Real Good Toys miniature dealer) when dying the shingles for this house. Batch dye or stain the shingles several days ahead of time so they will be dry when the time comes to use them (instructions are with the shingle dye).



Flooring: Applied sheet flooring, tile, or carpet should be installed in the completed dollhouse, but scoring and staining a plywood floor should be done now.

www.dollhouseworkshop.net/floorfinish



Painting: The order of assembly and painting is a back-and-forth process of test-assembly, marking, painting, and final assembly. There are three things to keep in mind as you do this:

1. **Glue doesn't stick to paint.** It does, however, stick to a part that has been first-coated and sanded. For this reason, parts that will be the same color can be glued together after one coat and sanding, but before the second coat of paint is applied.
2. **The quality of your paint job depends on sanding** after the first coat, and sanding is easiest and best while the parts are un-assembled.
3. **Where two colors of paint will be next to each other,** the neatest result will be achieved if the parts are marked and painted to just cover the mark, leaving the rest of the joint unpainted. That way, when they are glued together, the glue joint will have wood for strength, and the line between colors will be perfect (impossible to achieve with masking for painting)

B. Build the Front Steps (pack #D-96).

1. Glue together the 1st & 2nd Steps, lined up in back.
2. Paint (first coat) the Front Step Base assembly and the Treads.
3. Sand and second-coat the Treads and Base. If you intend to texture-paint the Front Step Base, do it before attaching the Treads

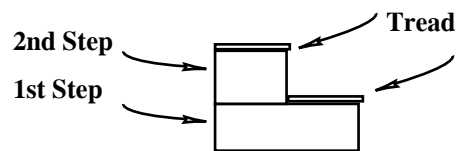

Texture Paint: For the foundations and anywhere else a textured surface is desired, base coat the surface with plain paint and second-coat with a mixture of paint and "Real Good Toys' Stucco Grit". Mix the Stucco Grit with paint and apply in slaps or short swirls



C: Paint all the walls now. Do not paint the edges. Use high quality interior semi-gloss latex enamel. Avoid old gloppy paint and poor quality paint brushes.

The First Coat goes on quick and soaks into the wood which reinforces the wood's grain so sanding clips off the surface fibers instead of pushing them around. Resist the temptation to sand and primp first... it will just make the wood fuzzy and make it more difficult to get a smooth final finish. Do not "double paint" (going back to overpaint where the paint has soaked in), it will make sanding more difficult.

Sand everything until the paint is smooth and transparent with the wood showing thru. Sand the clapboard **one course at a time**, with a folded piece of sandpaper. After a few courses, refold the sandpaper to keep the cutting action fresh.

Re-paint. The second coat goes on smooth and creamy, with plenty of paint (but no puddles). Sometimes a third coat is necessary.

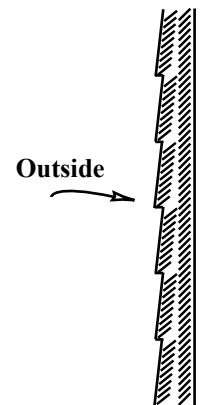

Pro tip: One coat of paint or primer on the inside surface reduces moisture-induced warping. Sand before assembly, and second-coat after assembly.

Paint the Connectors; do not paint the ends or in the grooves



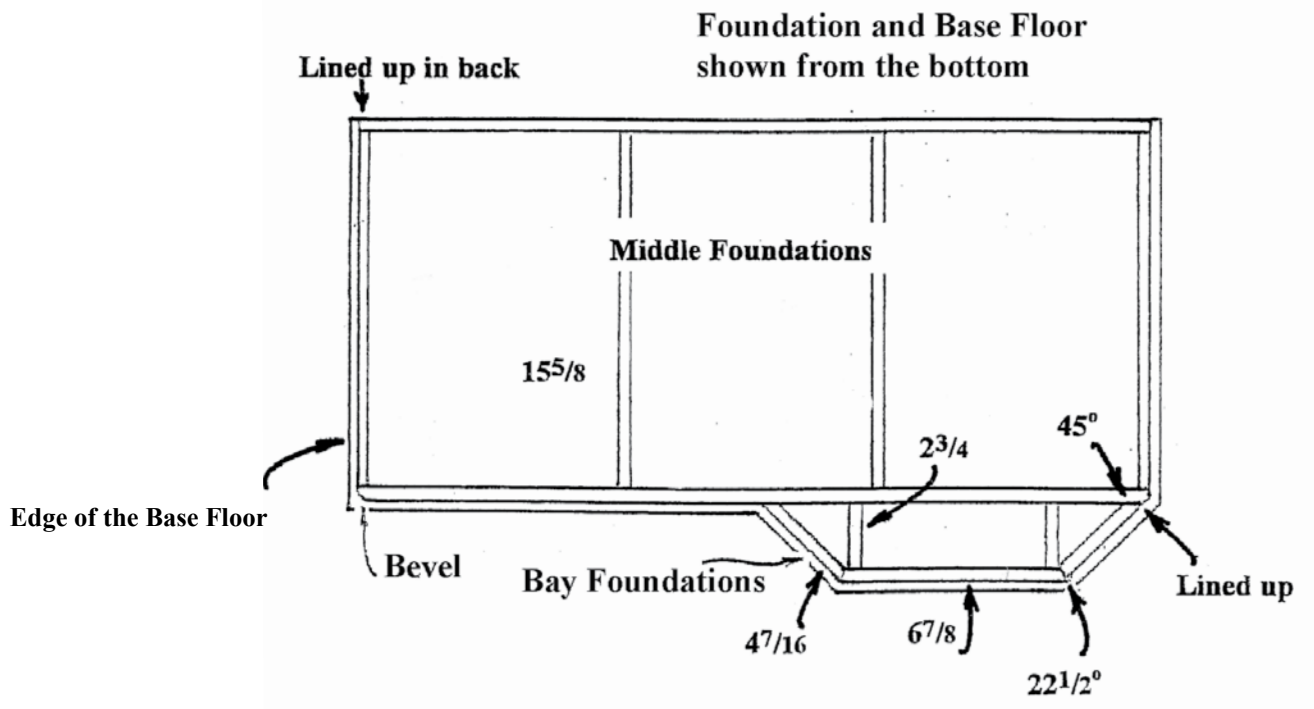

**Housebody Assembly:
the Foundation and Base Floor**

- 1. Glue and nail together the Foundation perimeter with the Long Foundations (31 9/16) overlapping the Middle Foundations (15 5/8).
- 2. Glue and nail the rest of the Middle Foundations within the Foundation Perimeter, spaced evenly.

Pro Tip: It is easiest to glue the Nosing onto the Floors now (see page 10), but it takes more space. The Nosing is vulnerable until the house is built; the floors can't be stacked or moved without great care. If you have lots of space to keep the floors safe and to lay them out for painting (see Section 4), attach the Nosing now. Otherwise, keep the Nosing bundled and protected until the house is built.



- 3. Glue, tape, and nail the Base Floor to the Foundation set, lined up at the back edge, with the bevels to the front, and spaced evenly side-to-side.

Weight the Base and Foundation set to lay absolutely flat on a flat worksurface as the glue dries. Getting the Base assembly flat is necessary for a flat house!

- 4. Glue and tape the Bay Foundation set together and to the Base and Foundation, lined up with the bevel and spaced evenly under the floor.

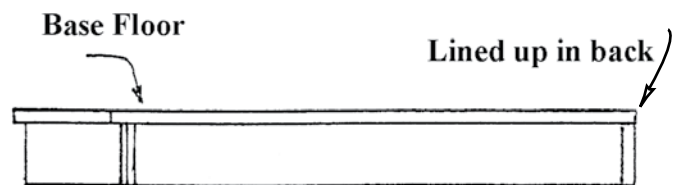
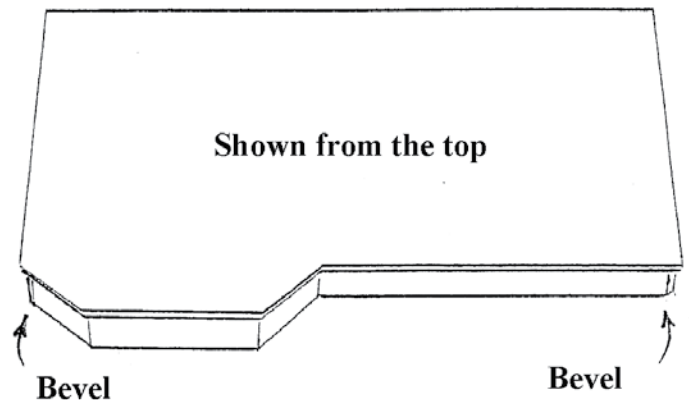

**Foundation and Base Floor
shown from the right end**

————— Let the glue dry —————

Set Up the Walls

1. Without glue, set up the 1st floor Walls and Connectors on the Base Floor (be sure the square edges of the 135° Connector corners are in line with the Floor panel, not at 45°, and that the narrower surface (5/8") of the 90° connector faces the front). Adjust the Wall layout until all the panels are straight up and down: the End Caps line up with the back of the Floor, and the Walls are parallel with the floor's edge (not all the same, but all approximately parallel; when the nosing is attached (pg. 6), the differences will be minimized).

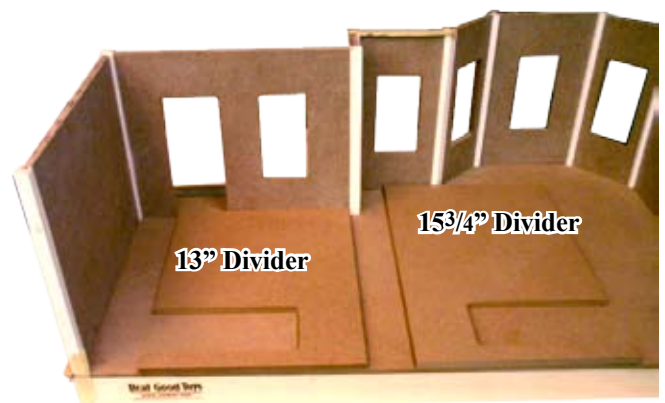
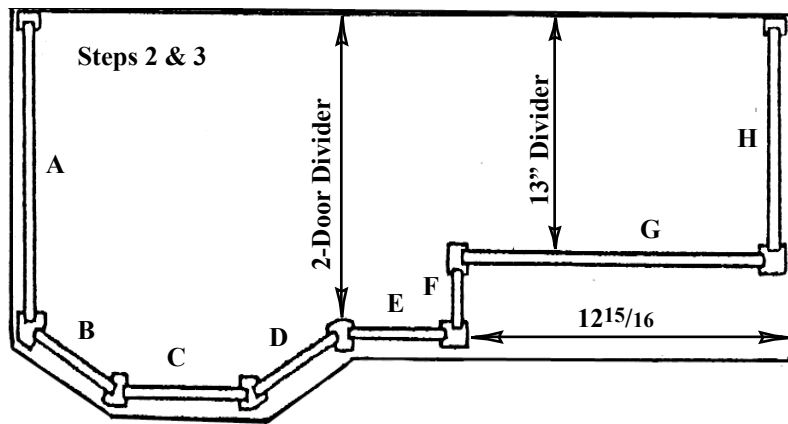
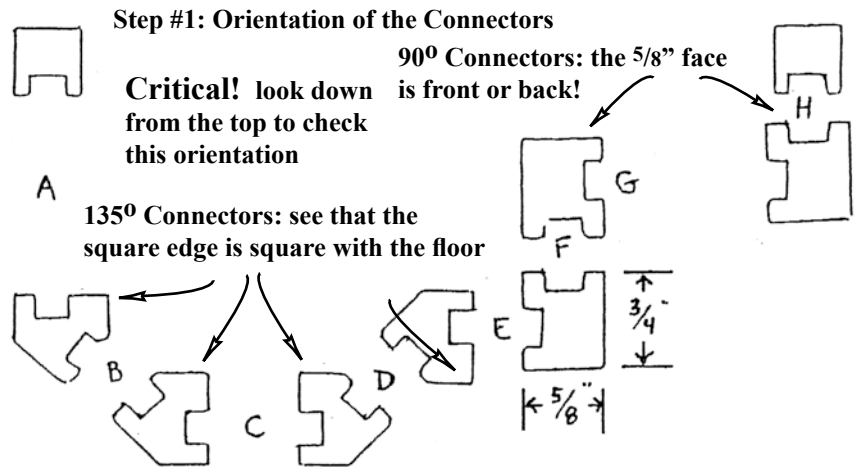

Pro tip: The 13" Divider measures from the rear edge of the Floor to the inside of wall "G". A 15 3/4 divider locates the 135° Connector on wall E. In the porch, measure 12 15/16 from the right edge of the Floor to the 90° Connector on Wall E.

2. Trace the inside and the outside of the Wall layout on the Floor. Paint the floor outside of the tracing to just cover the line.

3. Glue the walls to the Floor following the inside tracing. Set the 13" Divider against the back of wall "G" and a 15 3/4" Divider against the 135° Connector at the edge of wall E. These Dividers ensure the walls are straight up-and-down as the glue dries

4. Test, trace, and paint the under-side of the 2nd Floor (as in step #2). Glue the Second Floor panel in place; check the spacing. Use weight and tape for a tight fit. Make sure the rear edge of the Side Walls are flush and that everything is set straight and square. Make sure the house is flat on a flat surface as the glue dries.

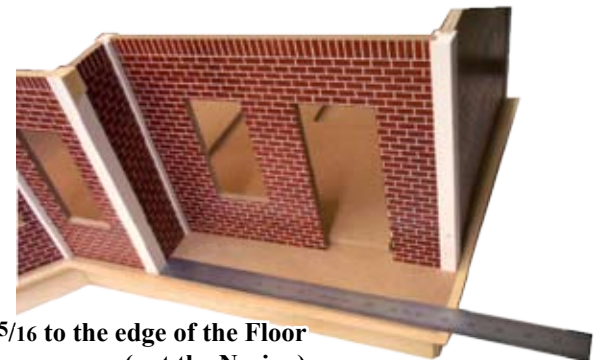

Measure 12 15/16 to the edge of the Floor (not the Nosing)

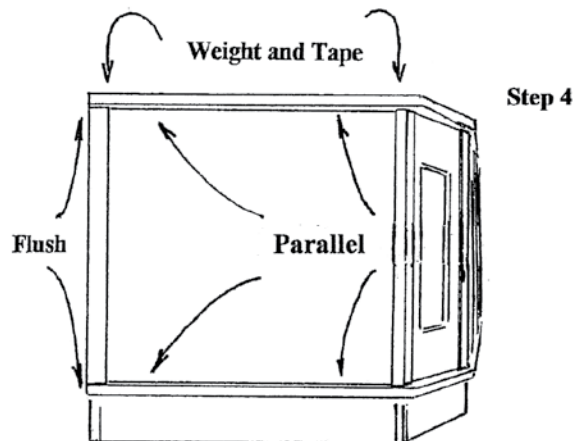

Let the glue dry

5. Assemble the Second Floor Wall Sections in the same manner as steps #1 and #2. Stand back from your house and check to see that all the Connectors line up.

6. Test, trace, paint, and glue the Third Floor Panel in place, as in step #4 above.

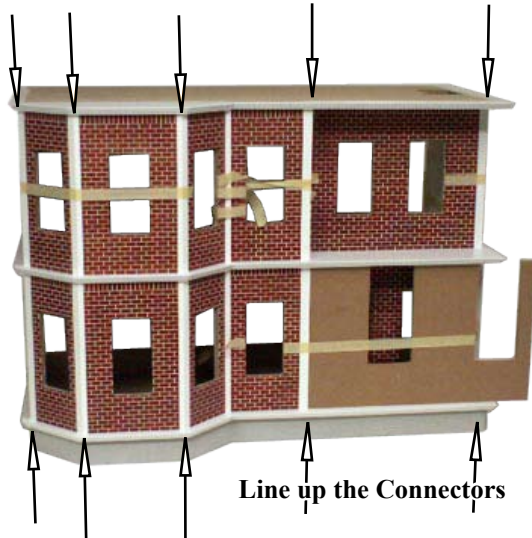

Line up the Connectors

Let the glue dry

step 6

Paint the space outside the walls

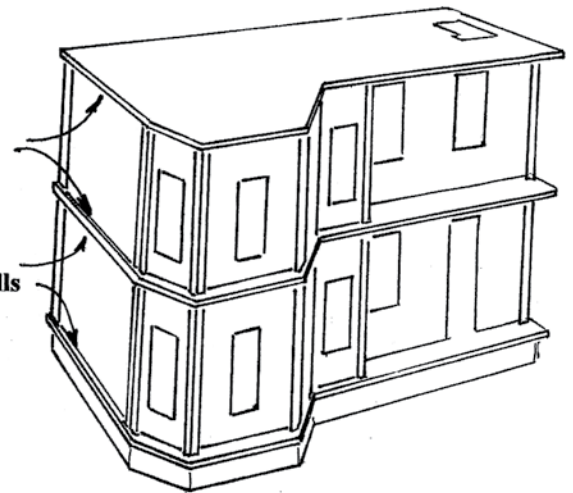

Tower Room Assembly

1. Assemble the tower room using two Tower Side Panels (the same as 15 3/4 dividers), two 90° Connectors and a 5" Wall.

Trace an Attic Divider and the thickness of a Roof on the 15 3/4" Dividers that will become the Tower Room Sides. Paint to cover the line, but leave some un-painted space for glue between the lines.

2. Position the Tower Room. Line up the right front 90° connector with the one below it.

Important: Lay a Divider flat on the third floor flush with the rear edge of the floor for final positioning of the walls to make the Tower Walls square with the back edge of the Third Floor.

Test, trace, and paint the 3rd Floor in front of the Tower Room

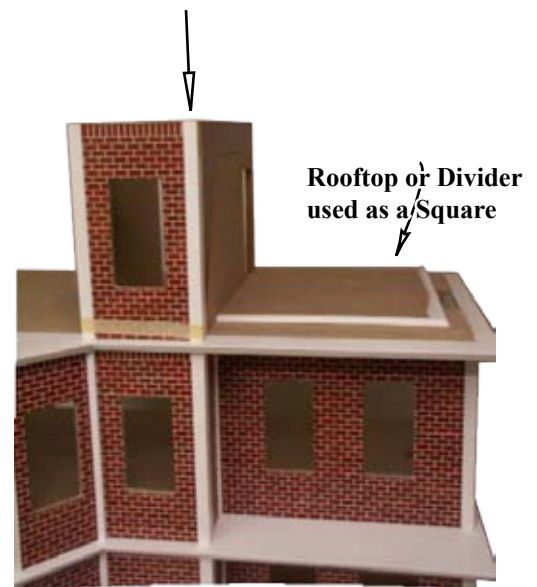

Rooftop or Divider used as a Square

Line up the Connectors

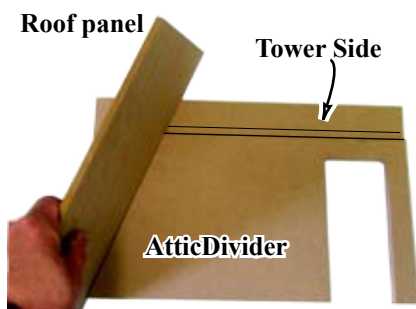

Trace

Exterior paint color

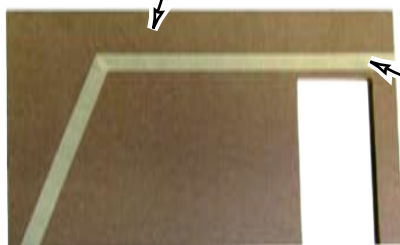

Paint



The roof will attach here

Let the glue dry

Roof Assembly

On the outside of all roof panels draw guidelines for locating Shingles. The first guideline on each panel to be shingled should be drawn one Shingle length (usually 1 1/4") from the bottom edge. Draw the rest of the guidelines spaced 1" apart.

Note: The Shingle Boards on the roof's corners will separate the shingling on the Front and Side Roofs, which are at different angles. That difference makes the guidelines not line up with each other. If you are not using the Shingle Boards, Transfer the guidelines from the Front Roof to the Side Roofs.

1. Set the Attic Divider close to the Tower side, lined up at the back of the Third Floor.

2. Glue and tape the Right Front Roof and Right Side Roof panels together. The Front Roof overlaps the Side Roof. **Do not allow to dry.** Immediately glue and tape this assembly in place to the Tower Side and the Third Floor. Move the Attic Divider and clean up glue squeezings, then put it back not-quite touching the Tower Side. Make sure the Front Roof is touching the Attic Divider all the way up-and-down. Tape.

3. Make the Side Roof parallel to the edge of the 3rd floor and lined up at the back of the 3rd floor. Tape it there.

When the glue is dry, repeat steps 1- 3 for the Left Roof set.

A. Identify the outside

This is the outside of the Roof Panels

Bevels

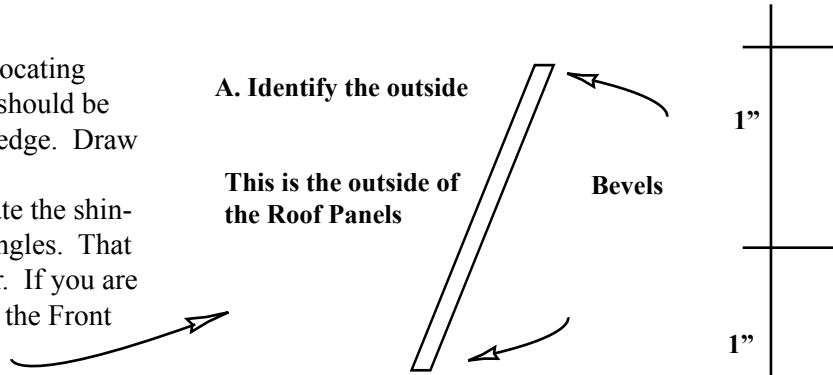

B. Draw guidelines on the Front Roofs

C. Transfer the guidelines to the Side Roofs at the corners

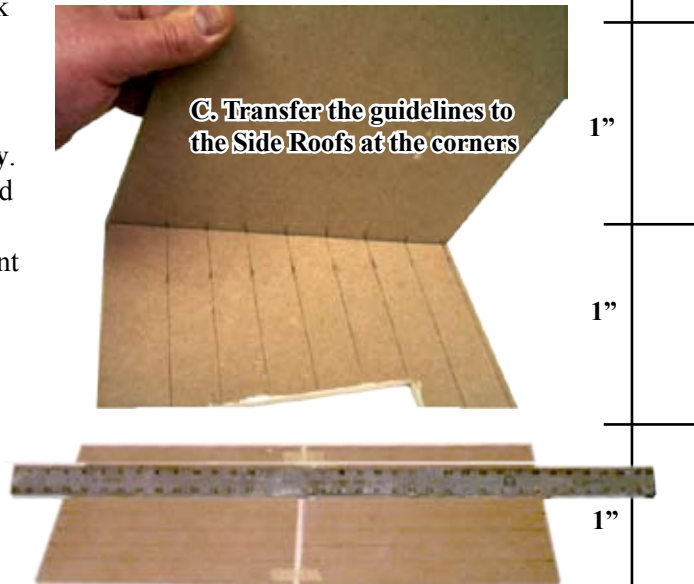

D. Connect the transfer marks for the Side Roof guidelines

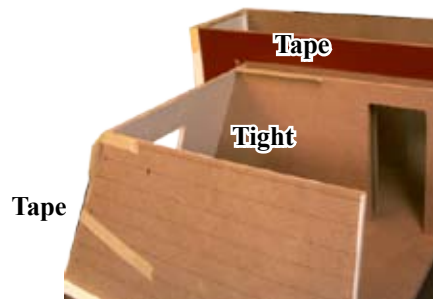

Tape and weight to make everything tight

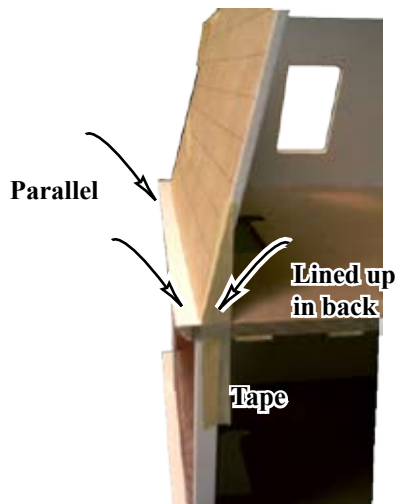

Let the glue dry

One
Shingle
Length
Guideline
Measure

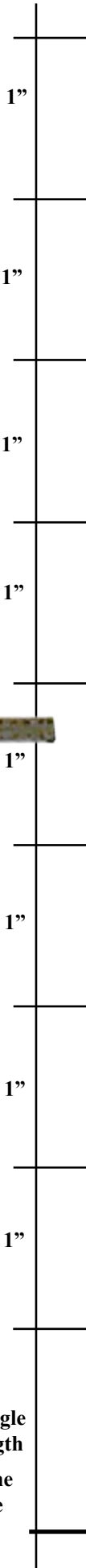

- 4. Attach the Tower Ceiling, flush at the rear, and centered side-to-side.
- 5. Draw shingle lines on the Tower Roof Panels.
- 6. Glue and Tape together the Tower Roof with the Front and Rear Panels overlapping the sides. You may prefer leaving off the Rear Roof for access to that space.
- 7. Glue the Tower Roof assembly in place on the top of the Tower Ceiling centered side to side above the walls of the tower room, and set back the same space from the front edge. Some builders turn the house up-side-down to attach the upper rails in the porch. If that is your intent, do not attach the Tower Roof yet.

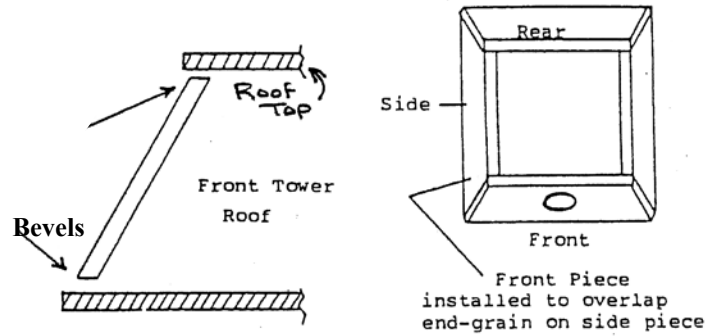

The round window opening faces the front.

The Roof Tops and the round window will be glued in place after shingling.

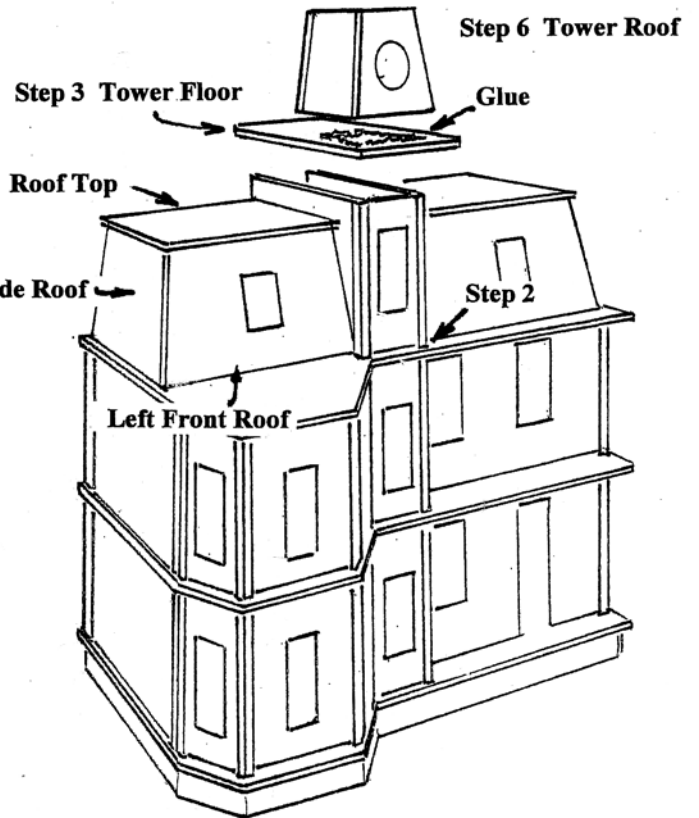

Attach the Edge Nosing

The Edge Nosing covers the edge of the plywood Floors and overhangs down below the Floors, with the top of the Nosing flush with the floor.

Attach the 3/8" Nosing to the edges of the Floors, beginning with the front of the left bay (M on the illustration) and work in both directions.

Attach the 1/4" Nosing to the Tower Ceiling and Roof Tops.

illustration #20

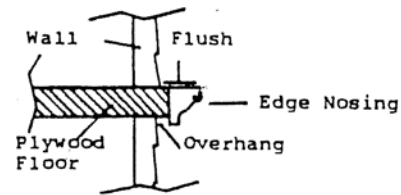

Let the glue dry

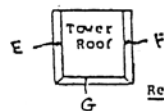

Refer to Parts List to Identify Edge Nosing Locations

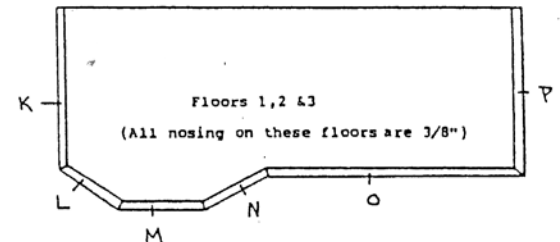
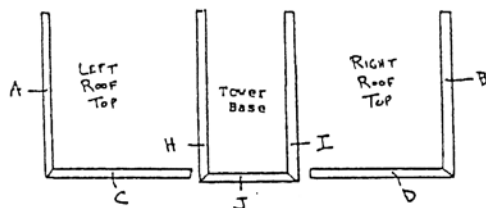

Paint the 3rd Floor outside of the Roofs before shingling

Assemble the Dormers

- 1. Glue together a Dormer Window frame, Pediment, Stool Cap, and Triangle. Set the window into the roof's cutout to help the parts line up in back.
- 2. Glue Dormer Sides to the window assembly lined up at the top edge of the Triangle.
- 3. Check the fit of the dormers on the house. Trim the lower corners of the roof cutout for a good fit. Glue the dormer to the roof, straight up-and-down.
- 4. Test then glue and tape together the Left and Right Dormer Roofs. Glue the Dormer Roofs to the Dormer Triangle and Front Roof.*

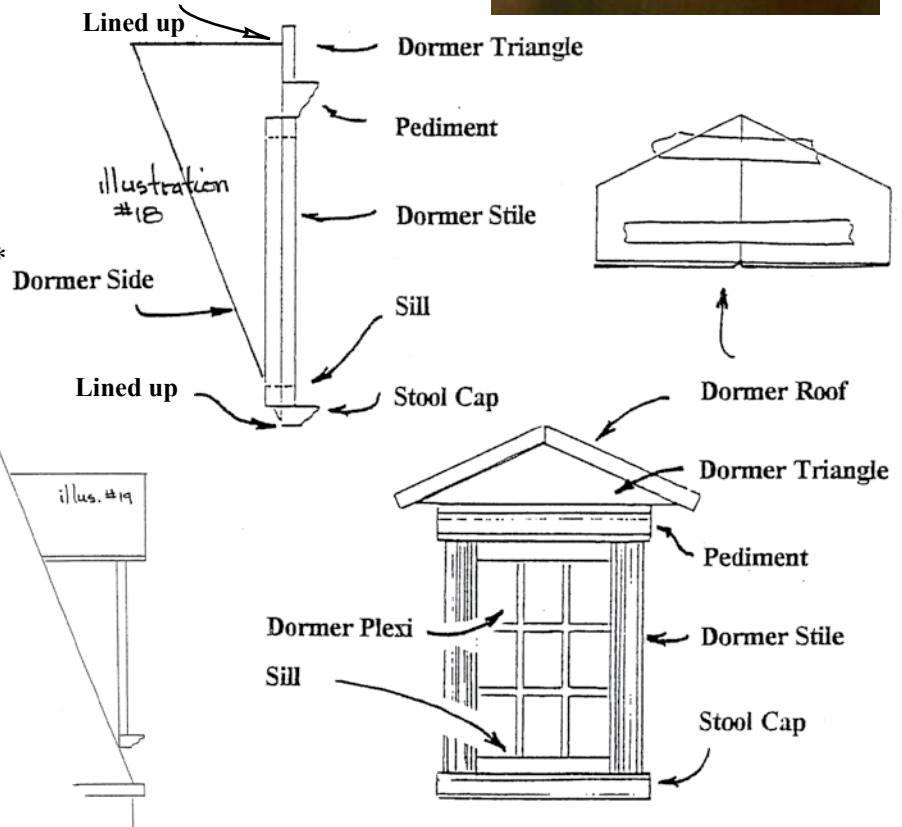
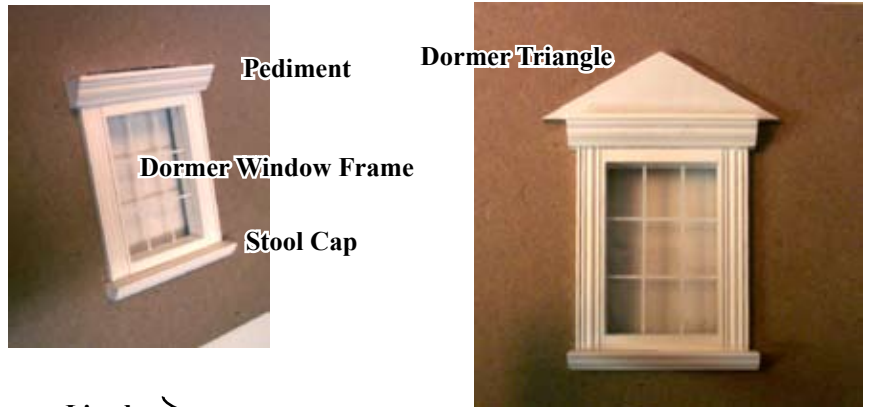

***Builder's Note: it is easiest to shingle the roof to here before attaching the Dormer Roofs.**

Pre-assembled windows and Door

Pull the pin out of the bottom of the Door to disassemble it for painting
Install all the painted Windows and Door in their openings.
Glue Pediments and Stool Caps to the Windows



Post and Railing Assembly

1. Paint and sand the Rails and Dowels before assembly. Wipe any paint out of the grooves, and do not paint the Rail ends at all. Paint the first coat and sand now, and paint the second coat after the railings are assembled

2. Match rails into assembly pairs. Measure from one end of the rails and mark the "Start" Dowel location (see the table below). Mark the rest of the Dowel locations at $\frac{5}{8}$ " spacing:

	# of rails	length	Start	dowels
A	13 Sets	$2\frac{13}{16}$ "	$\frac{15}{32}$ "	4
B	8 Sets	$2\frac{11}{16}$ "	$\frac{13}{32}$ "	4
C	2 Sets	$4\frac{7}{16}$ " @45°	$\frac{21}{32}$ "	6
D	2 Sets	$5\frac{7}{8}$ "	$\frac{7}{16}$ "	9
E	3 Sets	$2\frac{7}{16}$ "	$\frac{15}{32}$ "	3

3. Put a dab of glue in the groove by each mark for one Rail only of each assembly pair. Push a Dowel into the groove at each mark. Be sure all the Dowels are even, straight, and square. Let the glue dry.

4. Repeat step #3 for the second Rail of the assembly pair squeezing the Dowels in one at a time at the marks. Hold the Railing set in a square or lined up with the square edge of a piece of paper to make the Rail ends exactly line up. Final adjust the Dowels - - straight and square.

5. Assemble (18) $1\frac{5}{8}$ Flutepost & Postcap, (4) $1\frac{5}{8}$ Flutepost & Ball, and (4) $1\frac{5}{8}$ Flutepost, Postcap, & Ball assemblies.

Wait to install the Rooftop and Balcony Railings until the Shingling is done and the Rooftops are attached.

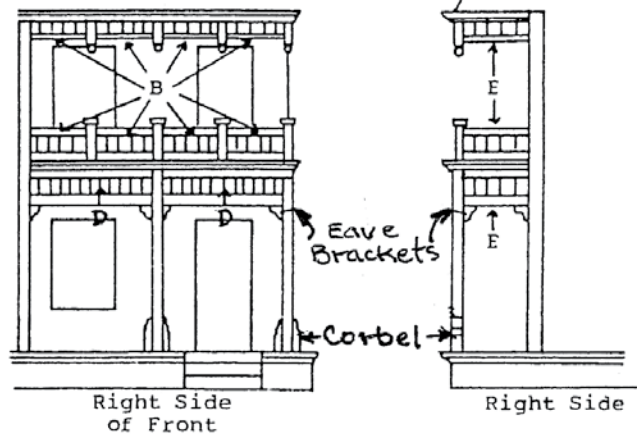
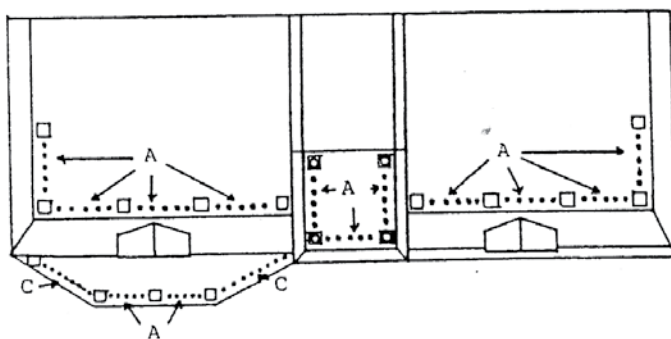
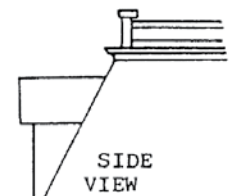
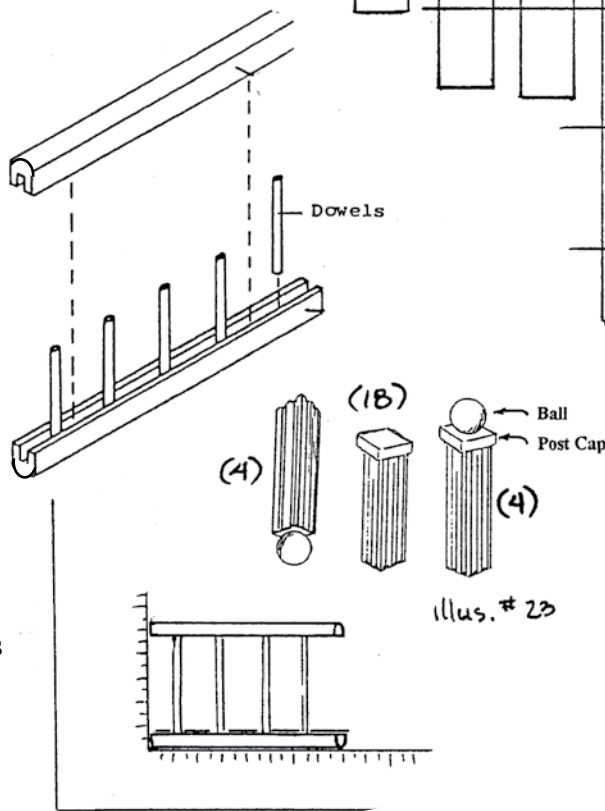
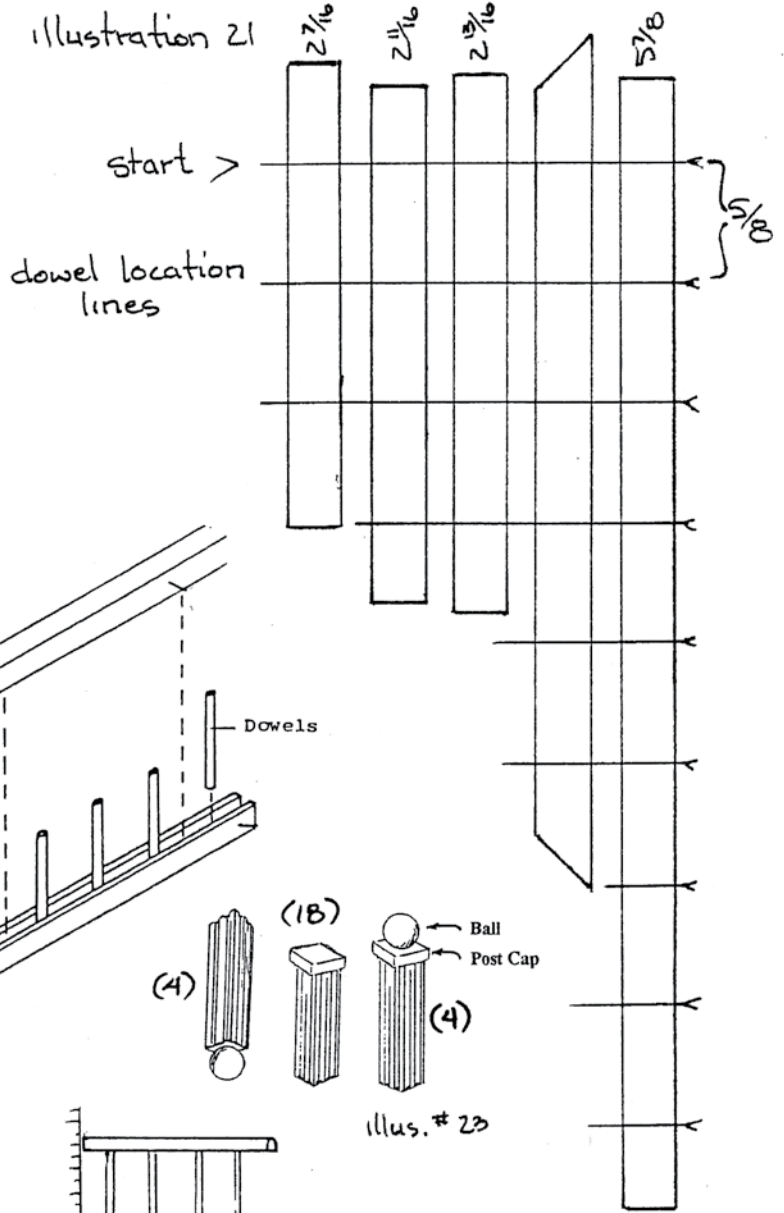
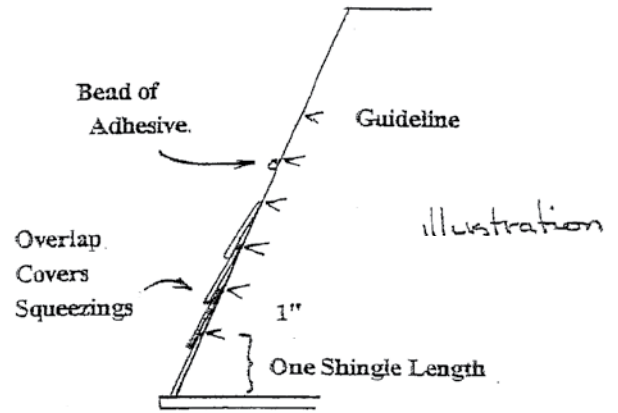
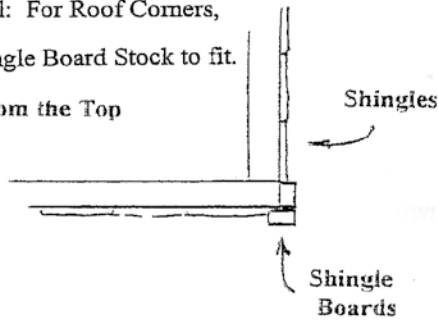

Illustration #26

**Optional: For Roof Corners,
cut Shingle Board Stock to fit.

View from the Top



1. Shingle the Roof: Glue: Use a thick *solvent-based* (not “water clean-up”!) panel adhesive available in caulking gun tubes at building supply stores. Trim just a little of the end of the tube for a tiny hole, giving a thin bead of glue. Always use good ventilation with solvent based adhesives.

Apply a thin line of adhesive just below the lowest guideline all the way across one roof. Press the top edge of a Shingle into the line of glue, squeezing out the excess. Hold the first Shingle and press another Shingle into the adhesive, tight to the first. Hold the next Shingle and press in another... etc. all the way across the roof, cutting the last Shingle to fit

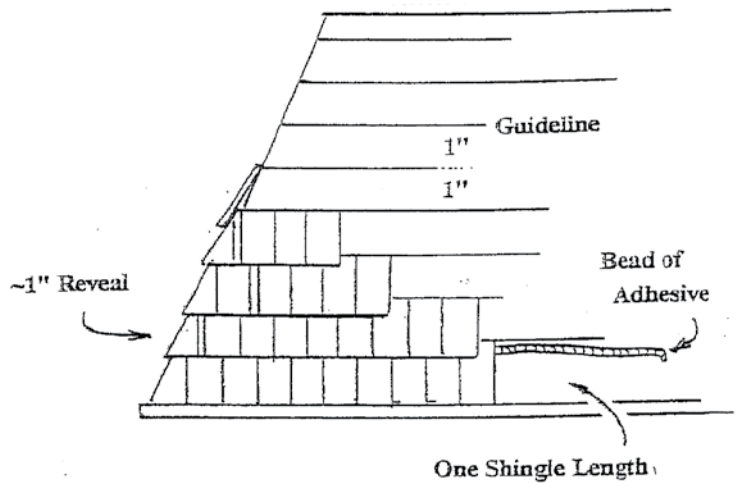

Continue up the roof one row at a time. Start the next row with a half Shingle so that the seam between Shingles is staggered back and forth as you go up the roof. Line up the top edge of each row (except the starters) with the guidelines.

Cut the top row of Shingles so that each row will have the same reveal.

Cut angled shingles for the corners of the Roof. When you glue a pair of shingles to the Roof's corner, the edge is straight up-and-down the roof.

For shingles on the Tower Roofs, glue the Corner pair on first on both edges, and fill in the shingles between them, splitting a shingle for the narrow last space.

illustration 26

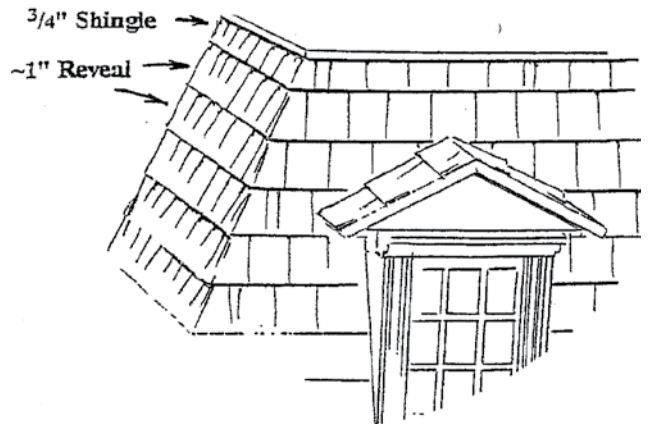

2. Install the Rooftops. Glue, tape, and weight the Rooftops to the Roofs and Tower Sides lined up in back. Support the edge of the Rooftop that's against the Tower Side with the Attic Divider while the glue dries.



Illustration #1

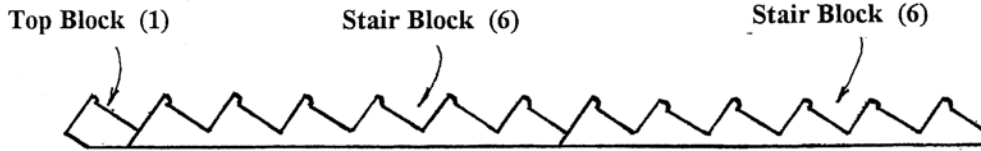

Stair Assembly:

Wait until the flooring and wallpapering are done before you install the stairs.

- 1. If you haven't already done so, square the corners of the stair holes. Use a utility knife, and work from both surfaces toward the center to avoid "split out": two cuts from each direction for each corner.
- 2. Test fit, then glue together the Stair Blocks, (Illustration #1).
- 3. Sand and paint or stain the Stairs and the Stringers before attaching the Stringers to the Stairs.
- 4. Test the Stairs with the Stringers in the stair hole.
- 5. Using a flexible set glue like silicone glue or Quick Grab[®] Cement, glue the inside Stringer to the Stairs, lined up at the bottom and top. Glue the outside Stringer to the stairs after the stairs have been installed, so that the fit under the floor will be perfect.

Illustration #2

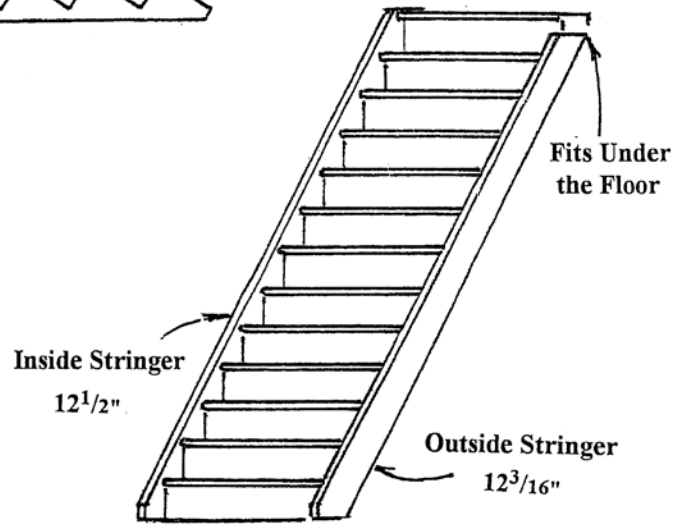

- 6. **Railings:** Glue one dowel (2⁷/₁₆"") to each stair tread spaced about 1/8 " from the edge, touching and glued to the front of the next-higher tread. Check to be sure dowels are straight and in line as the glue dries.
- 7. Spread a little glue in the groove of the Banister, and dab glue on the upper (blunter) end. Wiggle and slide the Banister onto the dowels and into position with the end touching the bottom of the next-higher floor.
- 8. Pinch the top end of each dowel into the groove of the Banister to ensure a good fit. Glue a 3¹/₂" Turnpost to the floor and lower end of each Banister.

Glue each Dowel in 3 places

Illustration #3

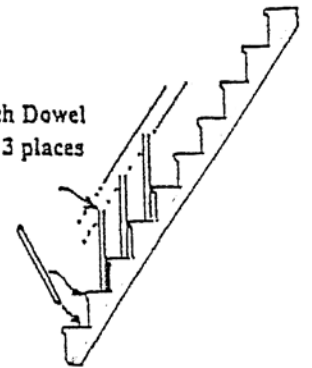

Illustration #4

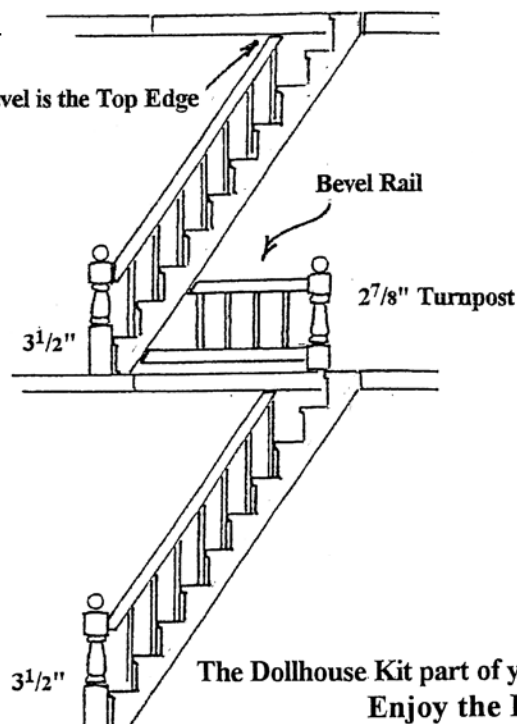
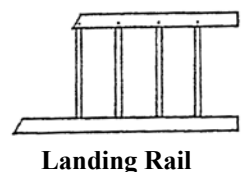

Illustration #5



- 9. Assemble and install the landing rail set as shown

The Dollhouse Kit part of your project is done. Enjoy the Rest!

Dividers can be moved, cut, modified, and rearranged any way you please. Make the inside of your Newport Dollhouse a reflection of your taste, style, and imagination.

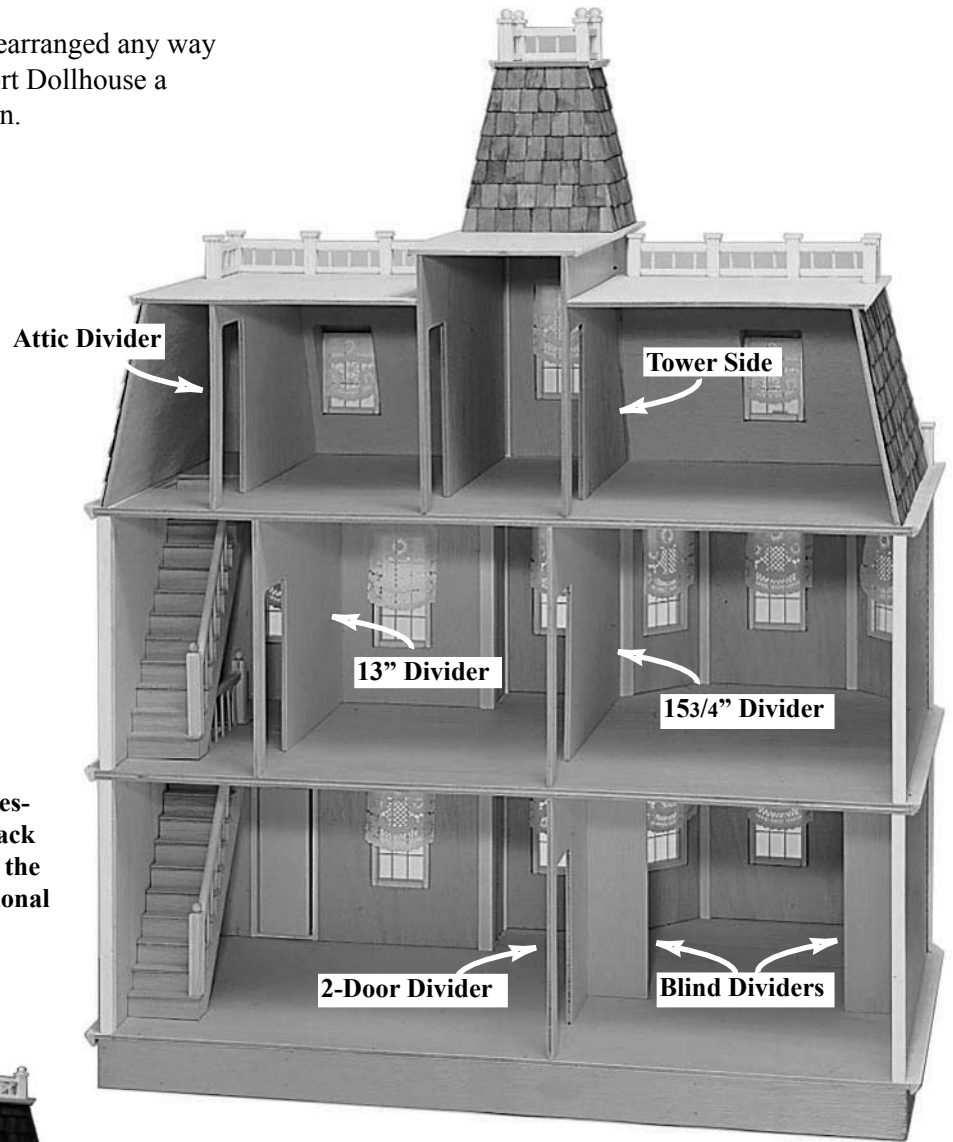

Blind Dividers give the impression of two rooms front-to-back without preventing access to the front room... their use is optional



#MM-36K Two Story Addition 12W x 12D x 24H
 pictured on the #MM-71 (each sold separately)

Options:

A wide variety of materials and accessories are available to help you achieve your dream house.

The following is a partial list of accessories available through your Real Good Toys dealer:

- #MM-36K Two Story Addition
- #SC: Copper Flashing (One Sq.Ft.)
- #Dye 1: Brown water soluble Shingle Dye
- #Dye 3: Gray water soluble Shingle Dye
- #T-10: 12" Turntable
- #T250: Assembled Turntable Base
- Wiring: visit www.dollhousewiring.com
- #EL66: Electrification tool and EZ punch (The EZ Punch piercing tool punches holes making nailing, screwing, and setting eyelets for electrical connections easier).